



Supported Equipment Manual

For the 8940 Device Manufactured by Symbol Technologies

Copyright © 1996 - 2006 by Connect, Inc.

All rights reserved. This document may not be reproduced in full or in part, in any form, without prior written permission of Connect Inc., 1701 Quincy Avenue, Suites 5 & 6, Naperville, IL 60540.

Connect, Inc. makes no representation or warranties with respect to the contents of this document and specifically disclaims any implied warranties of merchantability or fitness for any particular purpose. Further, Connect, Inc. reserves the right to revise this publication and to make changes to it from time to time without obligation to notify any person or organization of such revision or changes.

Trademarks

OpenAir Linux™, OpenAir Windows™, OpenAir 400™, PowerNet AirLine™, PowerNet Twin Client™, and PowerNet OpenAir™ are trademarks of Connect, Inc.

Other product names mentioned in this manual may be trademarks or registered trademarks of their respective companies and are hereby acknowledged.

Production

This manual was written, edited, and produced by:

Connect, Inc.
1701 Quincy Avenue,
Suites 5 & 6
Naperville, IL 60540
www.connectrf.com

Printed in the U.S.A.

Please let us know about any errors in this document at:

<http://207.241.78.223/isoxpert/calltrak.nsf/WebTracking?OpenForm>

Table of Contents

Chapter 1 • Introduction.....	1-1
Description.....	1-1
Picture.....	1-2
Setup Requirements.....	1-2
Accessories.....	1-2
Synchronization Tools.....	1-3
Scanner Setup.....	1-3
Chapter 2 • Terminal Setup.....	2-1
Downloading from the Web.....	2-1
Running Setup from a Download File	2-1
Installation.....	2-2
Running the Manager.....	2-4
Quick Start.....	2-5
Configuring the Manager	2-5
Cold Booting the Terminal	2-12
Configuring the 8940 Terminal for Download	2-13
Starting a Telnet Session	2-14
Standard Setup.....	2-14
Setup Using Twin Client Manager	2-14
Importing Custom Configurations	2-20
Terminal Setup Using Twin Client Menus	2-20
Authorizing PowerNet.....	2-22
Software Management.....	2-28
Airloader Auto-Configuration	2-28
Mobile Device Manager (MDM) Features.....	2-33
Sending Program and Configuration Files to the Terminal.....	2-43
Chapter 3 • Keypad Configuration	3-1
Diagrams.....	3-1
Table.....	3-4
Chapter 4 • Error Message Resolution Guide	4-1

This page is intentionally blank.

Chapter 1 • Introduction

Description

Features

- 12.1" SVGA touchscreen with 800 x 600 color display
- IP65 and 24G shock tested
- Embedded Microsoft® Windows CE OS
- Microsoft® Internet Explorer Web browser
- Optional 62-key flexible illuminated keyboard with 24 function keys
- Intel StrongArm® 1110™ power Processor
- 32 MB RAM/ROM32 MB non-volatile Flash
- Easily accessible touch-enabled membrane switch with 3 programmable keys, 2 LEDs, and Hi/Lo display
- Wavelink client-side emulator support infrastructure
- AirBEAM® Smart-enabled
- Heater option
- Ergonomic handles

Physical and Environmental Characteristics

- Dimensions: 12.2 in. H x 10.3 in. W x 3.4 in. D/30.9 cm L x 26.2 cm W x 8.6 cm D
- Weight: 9.25 lbs. / 4.2 kg (excluding mounting bracket and keyboard assembly)
- Power Supply: Internal wide range power supply (11-60 VDC); Transient spike and overcurrent/voltage protected; Reverse polarity protected; Connects directly to vehicle battery
- Display: high contrast/brightness display; Standard resistive touchscreen
- Keyboard: alphanumeric color-coded and sealed elastomer keyboard with tactile feedback; universal QWERTY layout to include VT100/220, 3270 and 5250 functions; audible key beep
- Interface Ports: Two RS-232 serial ports; keyboard port; USB port (host or slave), power input

Performance Characteristics

- Architecture: 32 bit
- Data Communication: RS-232 Serial Ports (2), USB, keyboard
- Terminal Emulation: 3270, 5250, VT100/220: supports Citrix, Windows Terminal Services
- Programming Tools: Microsoft Embedded Tools version 3.0, VRC 8900 SDK

User Environment

- Operating Temperature, without heater: 32° to 122° F / 0° to 50° C;
with heater: -22° to 122° F / -30° to 50° C
- Storage Temperature: -4° to 158° F / -20° to 70° C
- Humidity: 5% to 95% noncondensing
- ESD: 20kv air, 8kv contact

Wireless

- Network: Spectrum24[®] IEEE 802.11 and 802.11b compliant

To learn more about the VRC 8900 Series, visit www.symbol.com/mobile.

Picture

VRC 8900 Series Vehicle Radio Computer



Setup Requirements

Installation of PowerNet Twin Client requires at a minimum the following:

- A Pentium-class processor
- 32 MB of RAM
- 10 MB of free hard disk space available
- Microsoft Windows CE or CE 5 operating system

ActiveSync needs to be installed on the PC before downloading files to the terminal.
For instructions, go to www.MSDN.Microsoft.com.

Accessories

The following accessories can be ordered from Symbol:

- NiMH battery
- Optional AC power supply

Synchronization Tools

For desktop synchronization and communication, Active Sync (at least version 3.1) is freely downloadable from the Microsoft web site at <http://www.microsoft.com/windowsmobile/downloads/default.aspx>.

Scanner Setup

This terminal uses an external Decoded Scanner cabled to COM 1. Twin Client is coded to accept serial data from this port. Below are the instructions for configuring a decoded scanner for these terminals.

1. Make sure the Symbol Scan Wedge, if installed, is not enabled. Twin Client reads the scanner data directly and does not need a scan wedge. If it is left on, you will get COM port errors when the Scan Wedge and Twin Client both try to talk to the same port.
2. Make sure the "Serial Input" is off on the Keyboard tab of Twin Client setup.
3. Program the scanner this way:
 - a - (Set RS-232C Defaults)



SET RS-232C DEFAULTS



SET WAND DEFAULTS



SET SYNAPSE DEFAULTS



SET ALL DEFAULTS

b - (Set All Defaults)



SET RS-232C DEFAULTS



SET WAND DEFAULTS



SET SYNAPSE DEFAULTS



SET ALL DEFAULTS

c - RS-232 Host Baud Rate (9600)



600



4800



1200



9600



2400



19200

d - RS-232 Host Parity (None)



ODD



EVEN



MARK



SPACE



NONE

e - RS-232 Host Data Transmission Formats (<Data><Suffix>)



DATA AS IS



<PREFIX> <DATA>



<DATA> <SUFFIX>



<PREFIX> <DATA> <SUFFIX>

f - RS-232 Host Prefix/Suffix Values (Suffix)



PREFIX



SUFFIX

g - RS-232 Host Prefix/Suffix Values (<1><0><1><3>)



This page is intentionally blank.

Chapter 2 • Terminal Setup

Downloading from the Web

The PowerNet Twin Client software package can be downloaded from the Connect web site at <http://www.connectrf.com>. Click on *Partner Services* and then click on *Software Downloads*. Select the file named *PowerNet Twin Client for Symbol*.

Running Setup from a Download File

The downloaded file is a compressed archive. After extraction using a utility such as WinZip or PKWARE, folders are created on the hard disk as shown in the following figure.

Name	Size	Type
disk1		File Folder
disk2		File Folder
disk3		File Folder
disk4		File Folder

Click on the **Disk1** folder to view the files as shown in the following figure.

Name	Size	Type
inst3...	292KB	EX_ File
_ISD...	27KB	Application
_Setu...	34KB	Application Extension
_sys1...	172KB	WinZip File
_sys1...	4KB	HDR File
_user...	1KB	WinZip File
_user...	5KB	HDR File
Data.t...	1KB	TAG File
data1...	3,629KB	WinZip File
data1...	16KB	HDR File
hhp0...	4,270KB	WinZip File
lang.dat	5KB	DAT File
layout...	1KB	BIN File
os.dat	1KB	DAT File
setup...	185KB	Bitmap Image
Setup...	70KB	Application

Click on the **Setup** application and proceed to the following section entitled *Installation* for further instructions.

Installation

The InstallShield wizard runs and presents the following screen.

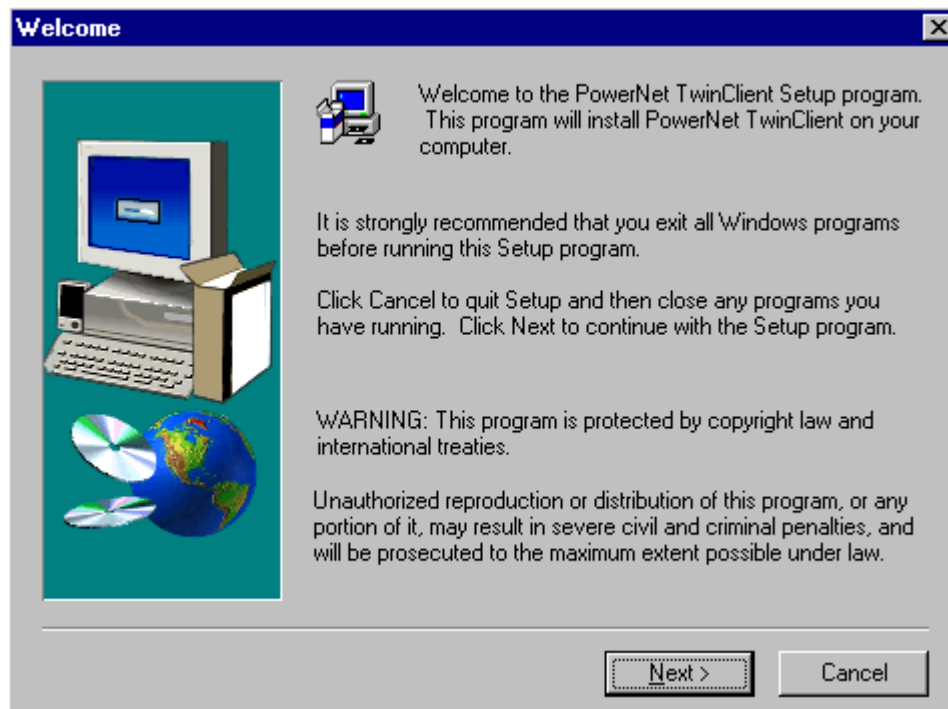

Click on **N**ext to begin the installation process.

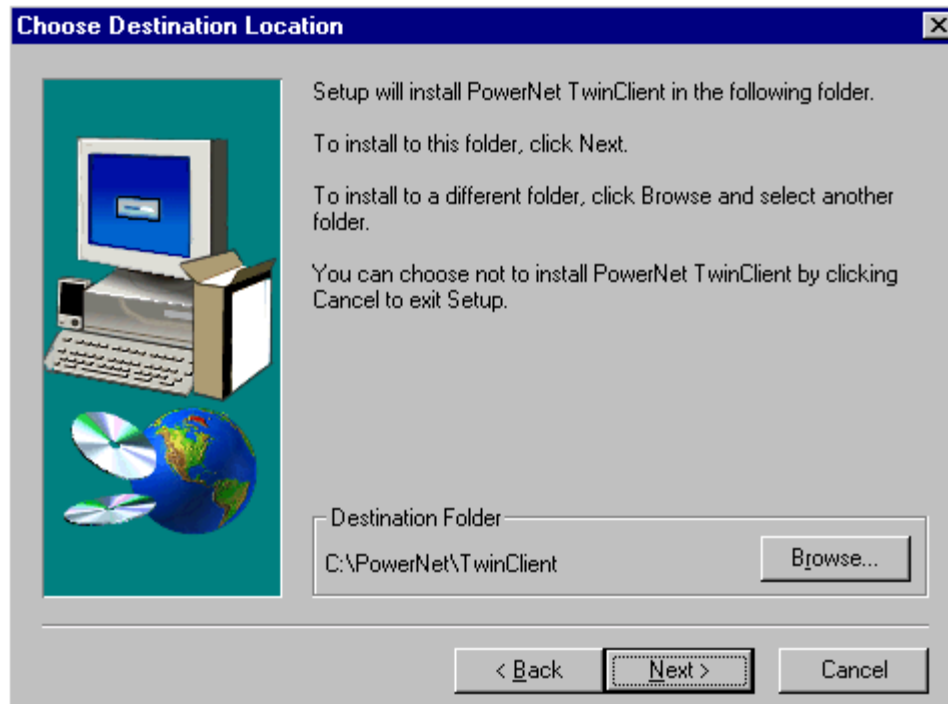

To change the default Destination Location, click on **B**rowse and select a location. Then click on **N**ext.

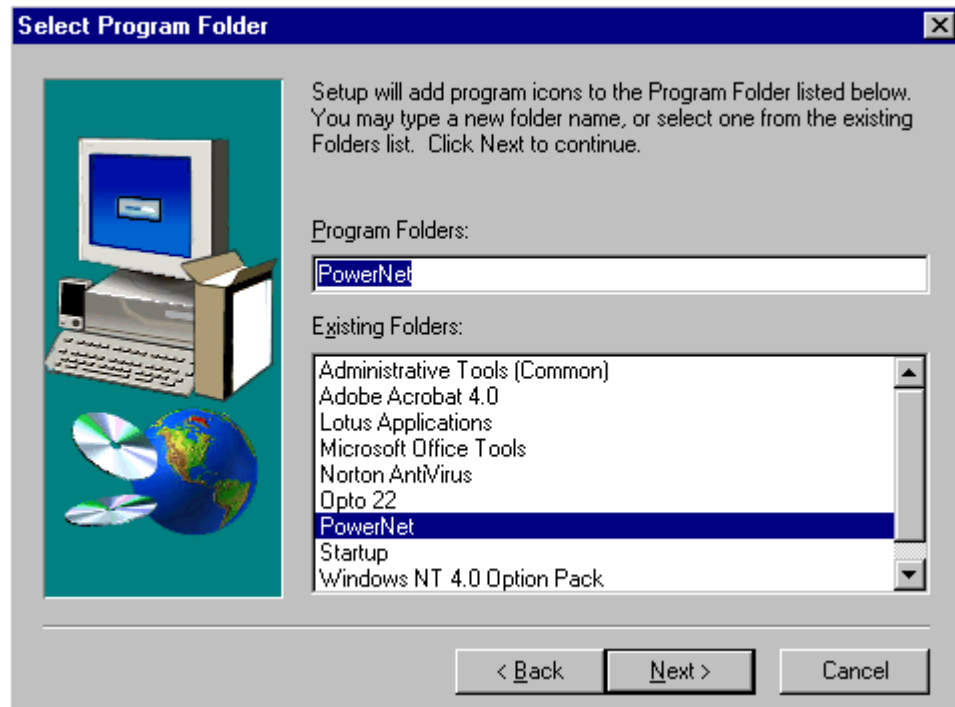

The default folder is **PowerNet**. This default may be changed either by selecting an existing program group or by typing in a new name at the prompt. Then click on **Next**.

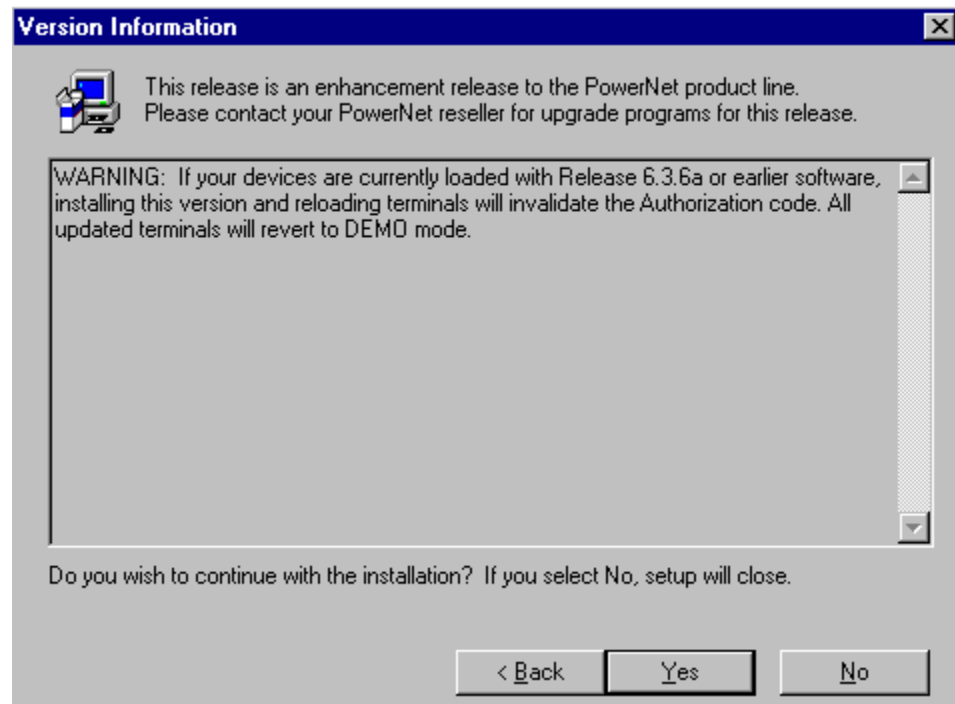

Read the warning. Select **Yes** to continue with the installation, or **No** to close the setup.



When the installation is complete, reboot the system to initialize the Twin Client software.

- a. To reboot the system immediately, click on **Finish**.
- b. To reboot later, click on the option to restart the computer later, and click on **Finish**.

Running the Manager

The PowerNet Twin Client Manager is the utility that manages the terminal software and configurations.

Select **Start, Programs, PowerNet, and Twin Client Manager**. The PowerNet Twin Client Manager screen appears as shown in the following figure. This is the administrator's main screen, and all functions are accessed from its menu bar, toolbar, and tabs.

Menu Bar

The menu bar provides access to the functions used to configure the terminals and manage their software.

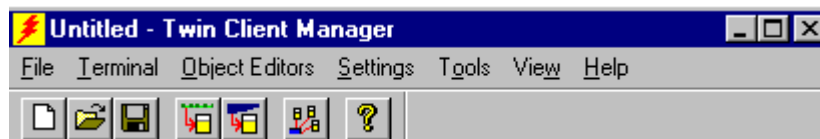

Toolbar

Found under the menu bar, the toolbar provides shortcuts to major features. The toolbar can be turned on or off by changing the Toolbar parameter found on the **View** menu. The shortcuts available from the toolbar are as follows:



Create a new terminal configuration.



Open an existing terminal configuration.



Save the current terminal configuration.



Download the configuration to the terminal.



Download software to the terminal.



Configure terminals automatically over the wireless network.



View the PowerNet Twin Client Manager version.

The PowerNet Twin Client Manager is now successfully installed and ready for use. The section below entitled *Quick Start* provides detailed instructions for quickly configuring the terminal and starting a Telnet session.

Quick Start

This section describes how to prepare the Twin Client Manager and the Symbol terminal for a Telnet session with the host. Following an initial serial download, the terminal software and configuration are managed automatically over the wireless network.

Note: Symbol terminals are normally delivered with Symbol files pre-installed. However, if the terminal does not have those files installed refer to the section entitled *Downloading Symbol 8940 Terminal Files* before proceeding.

Configuring the Manager

The first step is to configure the Twin Client Manager to meet site-specific requirements, and then prepare it for the automatic management of the terminal software and IP addresses. This simple procedure will require only a few minutes to complete.

Setting the Emulation

Click on **Start**, **Programs**, **PowerNet**, and **Twin Client Manager**. Select the **Settings** menu, as shown below.

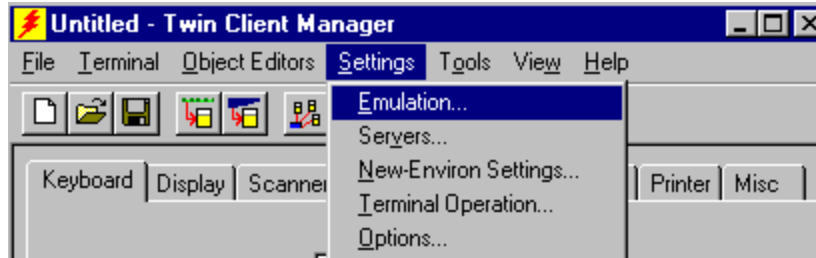

Click on **Emulation**, select the desired emulation, and click on **OK**.

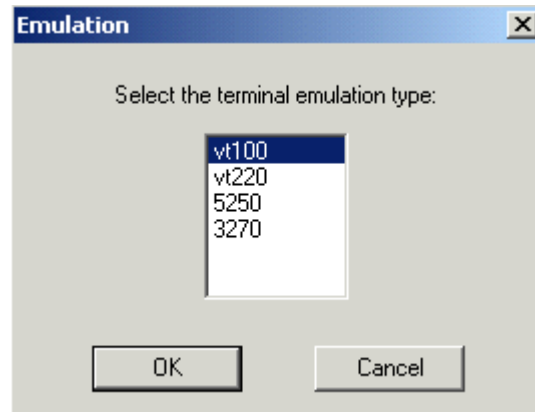

Setting the Servers

The Servers are the Telnet host systems the terminals will access.

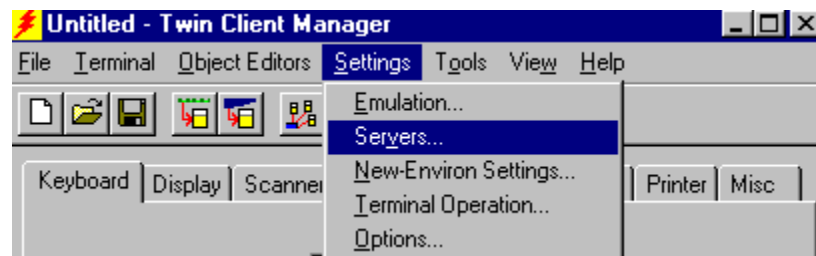

To set these addresses from the **Settings** menu, click on **Servers**.

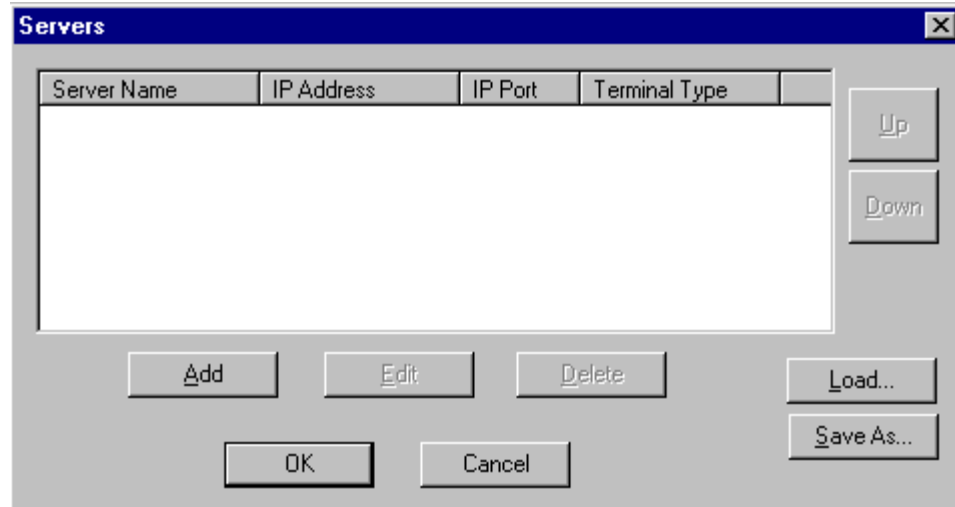

Then click on **A**dd.

Note: Use the **L**oad button if you want to load an .svr file. Use the **S**ave As button if you want to save your file as an .svr file.

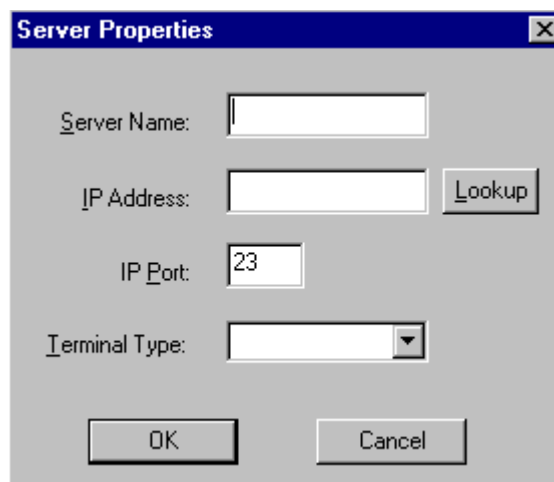

Enter the server name, IP address, IP port (normally 23 for Telnet servers), and terminal emulation type. Click on **O**K. Repeat this step for each Telnet server the terminals are required to access. If an error is made in the server name, IP address, IP port number, or terminal emulation type, click on the line that is in error and then click on the **E**dit button to make the corrections.

Terminal AirLoader and AirBEAM Operations

In the Twin Client menu under Settings, choose Terminal Operation.



Run AirLoader on terminal can be selected, the AirLoader server IP address can be entered, and the Windows CE options of Run application at startup and Hide task bar can be selected, as shown below. Also, there is an option to Use GUI menus and screens that makes the terminal program act more "Windows-like". Click on **OK** after entering information.

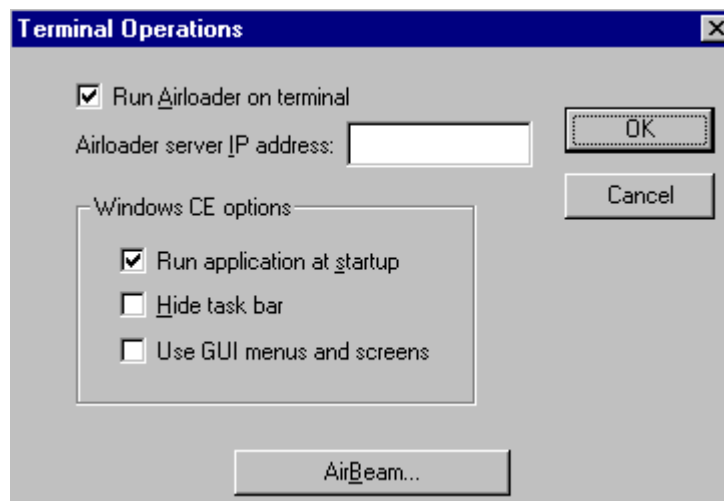

See the AirBEAM Operation section in the Symbol Twin Client manual for instructions on the AirBEAM option in this screen.

Setting Terminal Model and COM Port

The terminal model is 8940, and the default serial connection is through COM1. To select a specific Symbol terminal model and keypad, or to change the COM port assignment, click on the **Options** menu as shown.

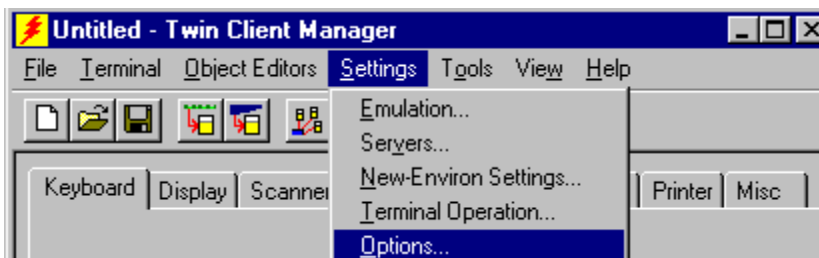

To maintain compatibility with existing Symbol Telnet client keyboard layouts, a specific terminal model and keypad must be selected from the Terminal Model window.

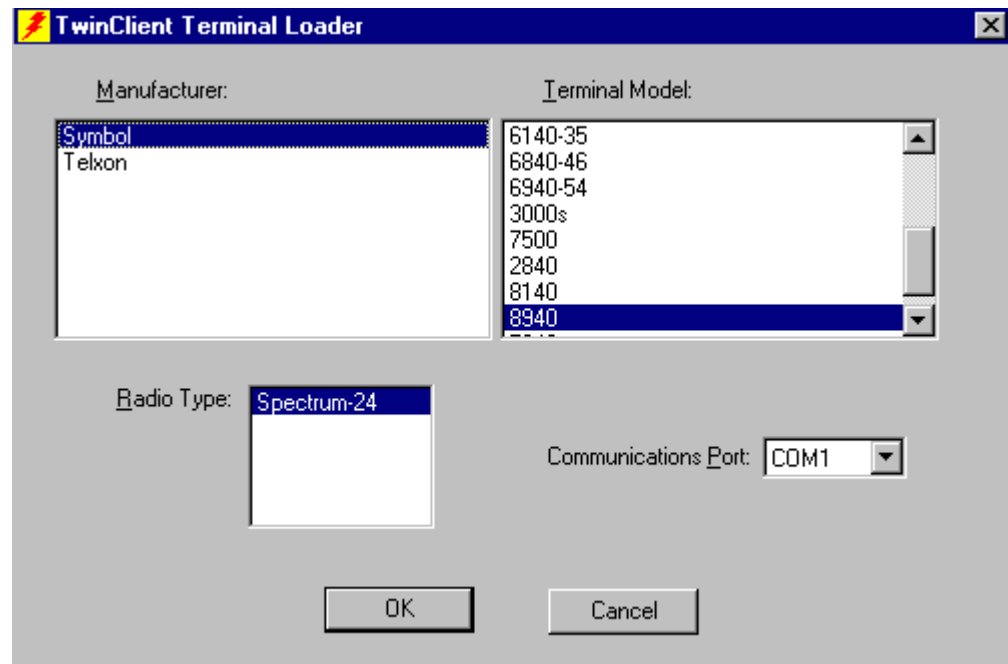

Select the **8940** terminal model option under **S**ettings, **O**ptions, and **T**erminal Model.

Note: Click on **N**ew the first time around to ensure that all defaults are set, especially when changing emulations.

Saving the Configuration

Click on **F**ile and **S**ave **A**s. Enter a name for this configuration.

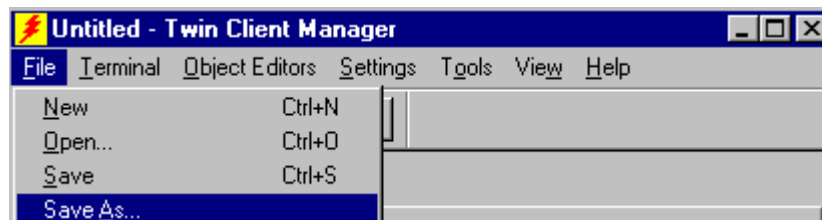

For the purposes of this example, the name is vt100.



Setting Airloader Auto-Configuration

The configuration download and IP address assignment for each terminal will take place automatically by setting the Airloader Auto-Configuration options.



Click on the **Airloader** option in the **Tools** menu.

Note: If the Airloader Auto-Configuration window does not display the options, click on the **Advanced**<< button.

If multiple network adapters are installed on the PC, ensure that the desired network adapter is selected. The adapter selection can be changed by clicking on the **Change** button.

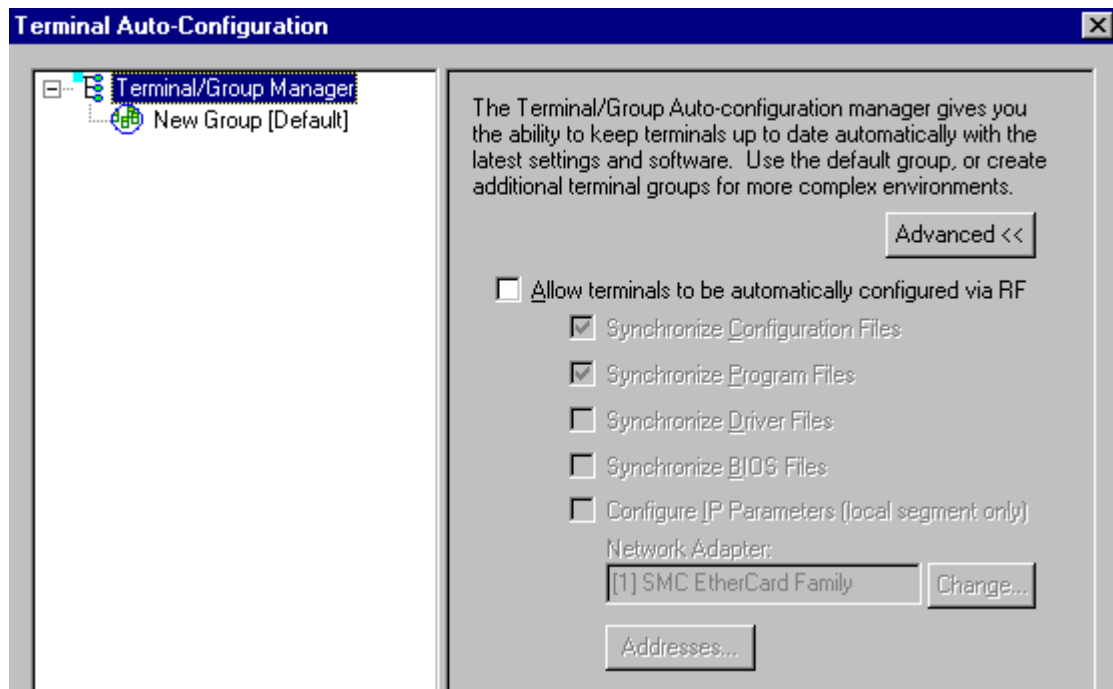

This powerful software management tool is described in detail in the section entitled *Airloader Auto-Configuration*. For now, it is sufficient simply to use it for assignment of the initial terminal configuration and IP address, both of which can be easily changed later. Ensure that all of the check boxes are checked as shown above.

To assign terminal IP addresses automatically over the wireless network, check all of the boxes as shown above. Then click on the **Addresses** button and enter the desired range in the **From** and **To** boxes as shown in the following figure.

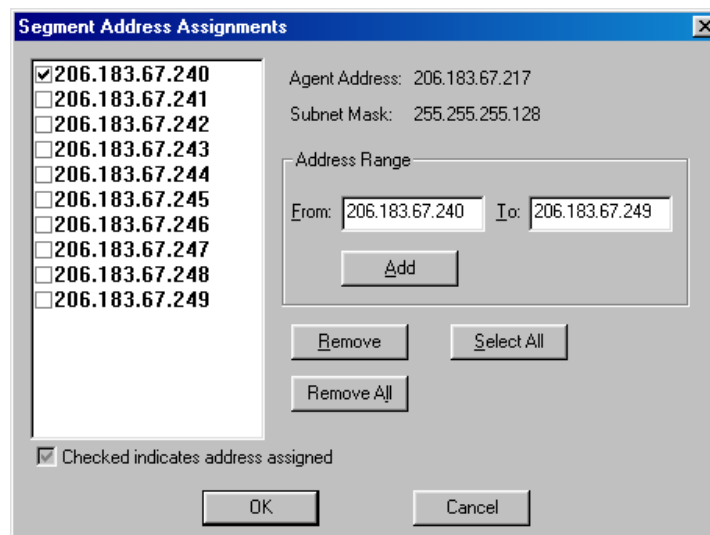

After setting the address range, click on **OK** to return to the Airloader Auto-Configuration screen and then click on the box next to **Terminal/Group Manager**.

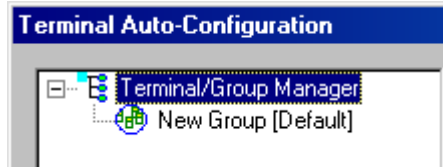

The display expands to show the default terminal group. Next, click on the **New Group** icon and use the **Browse** button to select the configuration file saved earlier.

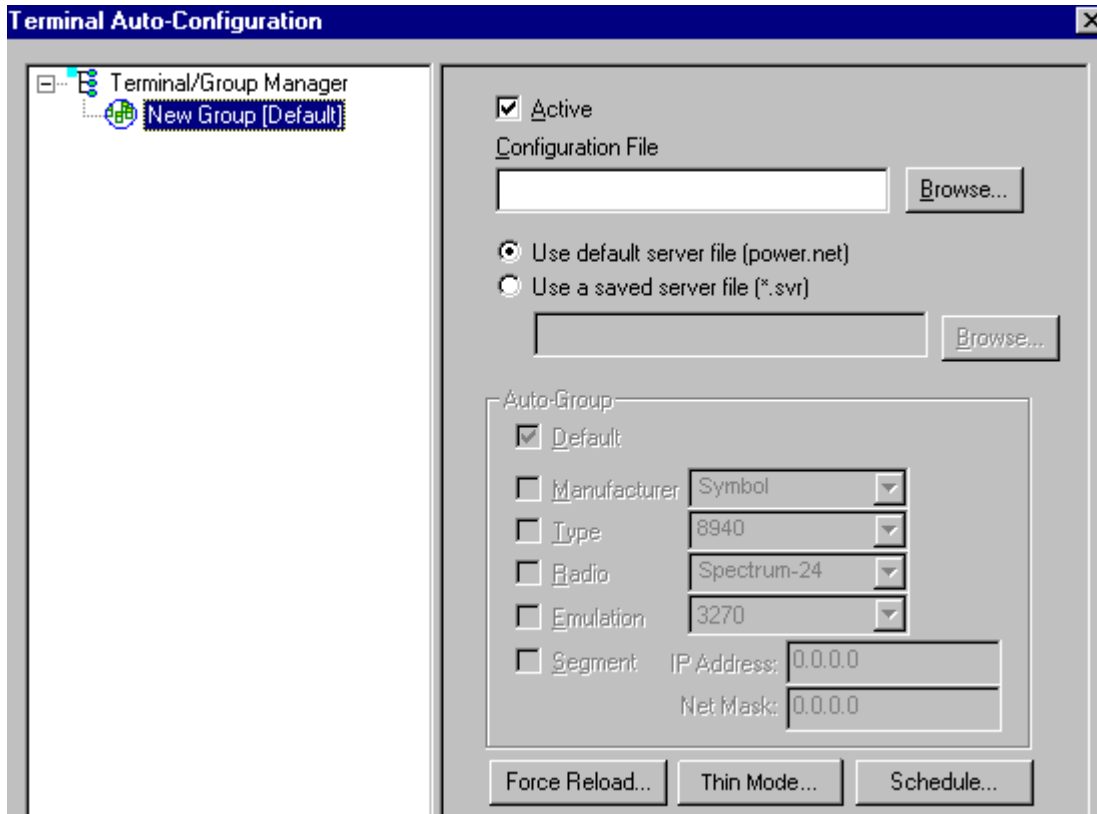

Check the **Active** box, and the system is now configured to automatically download IP addresses, software, and configuration files to the terminals. Click on the  box in the upper right corner to return to the main menu.

Note: The software does not need to be authorized now. It can be authorized later, after a Telnet session has been established. See the *Authorizing PowerNet* section.

Cold Booting the Terminal

Cold boot the terminal to update terminal software and/or configuration.

Mode	Press Power button...
Suspend or resume operation	1 – 6 seconds
Warm boot (soft reset)	6 – 15 seconds
Cold boot (hard reset)	15 seconds or more

Note: The ActiveSync cable must be disconnected in order to boot the terminal.

Configuring the 8940 Terminal for Download

The terminal download requires a serial connection between the terminal and the PC through a cable. In preparation for this download, connect the cable to the selected serial port on the PC and to the 8940 terminal.

On the PC, click on **Start, Programs, PowerNet, and Twin Client Manager**. Under the **Terminal** menu, choose **Send Program Files to Terminal**, as shown in the following screen.

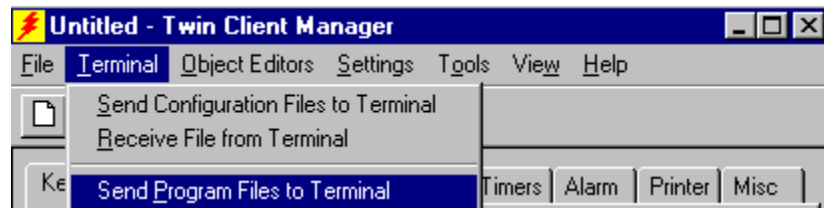

The following screen is displayed.

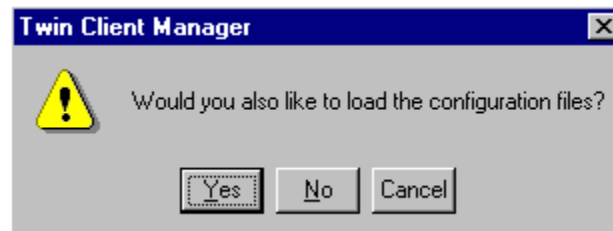

Choose **Yes** at the prompt. The following screen is displayed.

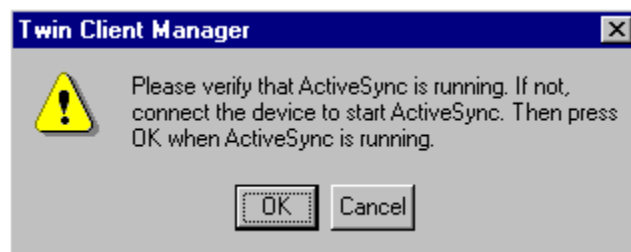

Click on **OK**.

The PC is now configured to download to the terminal.

Starting a Telnet Session

At the Twin Client main menu on the terminal, press any key to establish the connection. Until the terminal has been authorized, the following screen is displayed.

```
RECOVERABLE ERROR
Terminal not
Authorized for
Twin Client

Keypress to Continue...
```

It is not necessary to authorize the terminal at this time, so press any key to continue. The terminal will establish a connection with the host system and start emulation.

After a Telnet session has been successfully established, the terminal will remain in session for a maximum of 30 minutes at a time until it has been authorized. Once authorized, there is no software restriction to the session time. The instructions for authorizing the terminal are presented later in *Authorizing PowerNet*.

Standard Setup

The default terminal setup is sufficient for most installations. However, to meet site-specific requirements, it may be necessary to customize terminal operation. The standard setup options simplify this process and can be modified by the following methods:

- Using the Twin Client Manager.
- Using the Twin Client terminal menu system.

To simplify the task for experienced Symbol installers, the standard setup options of both the Twin Client Manager and the terminal menu system match those of other Symbol products. As an additional conversion aid, customized Symbol configuration files can be imported and automatically converted to Twin Client.

This section describes how to use the Twin Client Manager and the terminal menu system to set up the terminal. Also described are the methods for authorizing the terminal software.

Setup Using Twin Client Manager

The Twin Client Manager provides a **Standard Settings** tab for automatic setup of the terminals. The options within this tab vary according to the emulation selected, each of which is described below. Click on **Standard** under the **View** option in the main menu.

VT Settings

Select the VT emulation setup by clicking on the **Settings** menu and then the **Emulation** menu, as shown below.

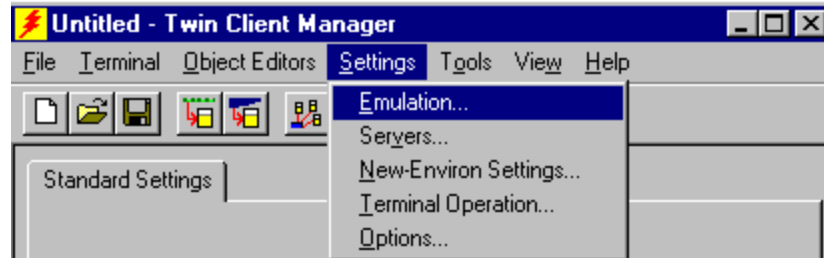

Then click on the **VT100** or **VT220** selection, as shown below.

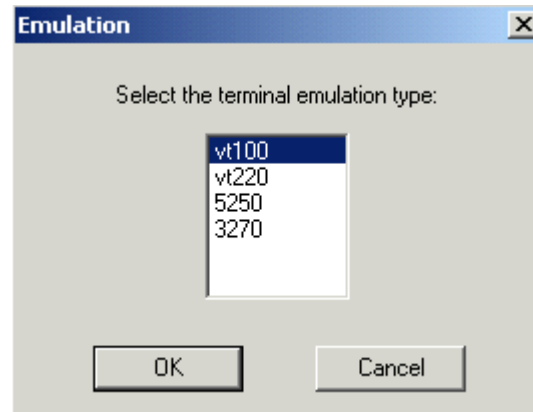

Click on **OK** after the selection is made, and return to the main Twin Client Manager menu. The standard settings tab will now reflect the settings for VT emulation.

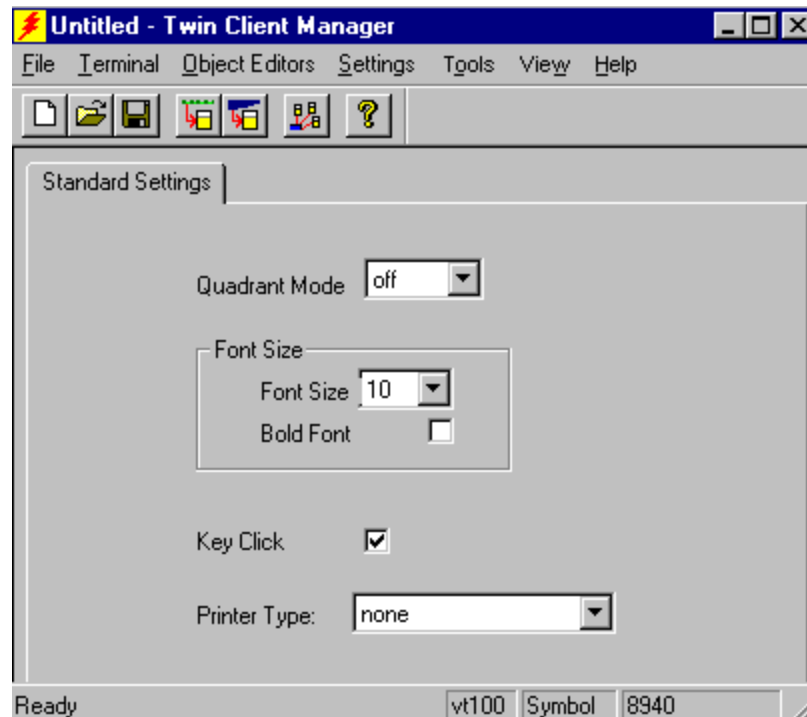

Quadrant Mode

This scrolling list option defines the rules by which the terminal display is positioned in the larger host display. As defined by Twin Client, quadrants are fixed position "windows" in the host display, and the terminal display is located on whatever quadrant contains the current cursor position.

Off disables quadrant processing and Twin Client simply centers the current host input field in the terminal display.

On enables quadrant processing. However, input fields that cross quadrant boundaries result in a shift to the left in order to locate as much of the current input field on the terminal display.

Soft always positions on a quadrant boundary regardless of input field boundaries. Viewing keys are enabled.

Hard is the same as **Soft** except the viewing keys are disabled.

Lock locks the terminal display origin (upper left corner) to fixed row and column (x,y) coordinates in the host display. The coordinates are zero-based.

Font Size and Bold Font

Font size has a scrolling list of font size options. Bold Font has a check box that enables (checked) or disables (unchecked) the display of characters in bold font.

Key Click

This check box enables (checked) or disables (unchecked) audible key clicks from the terminal. The default value is **on** (checked).

Printer Type

This scrolling list selects the attached printer type. The default value is **none**, indicating that no printer is attached.

5250 Settings

Select the 5250 emulation setup by clicking on the **S**ettings menu and then the **E**mulation menu, as shown below.

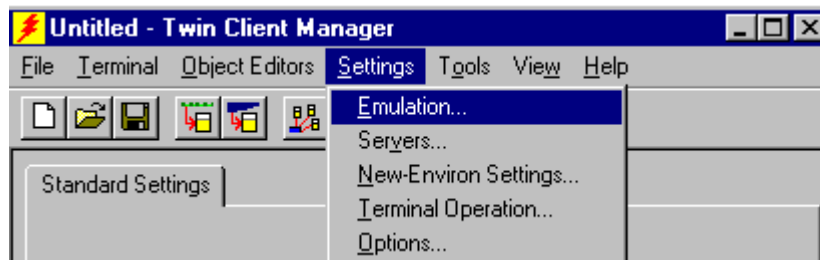

Then click on the **5250** selection, as shown below.

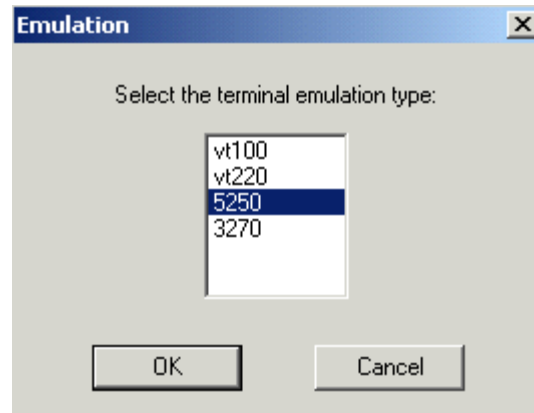

Click on **OK** after the selection is made, and return to the main Twin Client Manager menu. The standard settings tab will now reflect the settings for 5250 emulation.

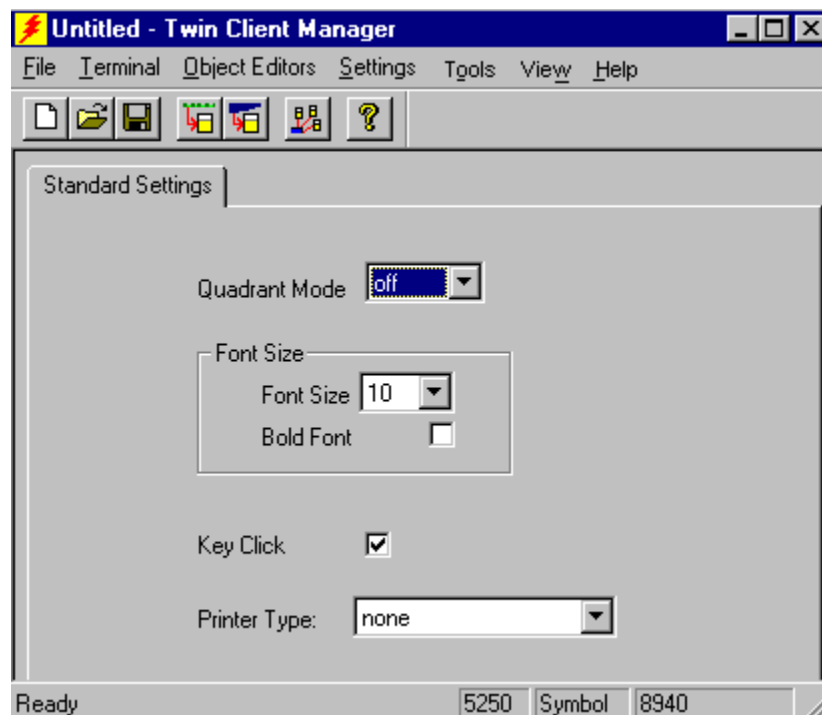

Quadrant Mode

This scrolling list option defines the rules by which the terminal display is positioned in the larger host display. As defined by Twin Client, quadrants are fixed position "windows" in the host display, and the terminal display is located on whatever quadrant contains the current cursor position.

Off disables quadrant processing and Twin Client simply centers the current host input field in the terminal display.

On enables quadrant processing. However, input fields that cross quadrant boundaries result in a shift to the left in order to locate as much of the current input field on the terminal display.

Soft always positions on a quadrant boundary regardless of input field boundaries. Viewing keys are enabled.

Hard is the same as **Soft** except the viewing keys are disabled.

Lock locks the terminal display origin (upper left corner) to fixed row and column (x,y) coordinates in the host display. The coordinates are zero-based.

Font Size and Bold Font

Font size has a scrolling list of font size options. Bold Font has a check box that enables (checked) or disables (unchecked) the display of characters in bold font.

Key Click

This check box enables (checked) or disables (unchecked) audible key clicks from the terminal. The default value is **on** (checked).

Printer Type

This scrolling list selects the attached printer type. The default value is **none**, indicating that no printer is attached.

3270 Settings

Select the 3270 emulation setup by clicking on the **S**ettings menu and then the **E**mulation menu, as shown below.

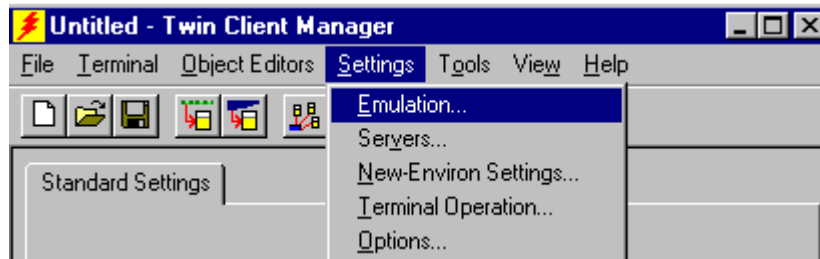

Then click on the **3270** selection, as shown below.

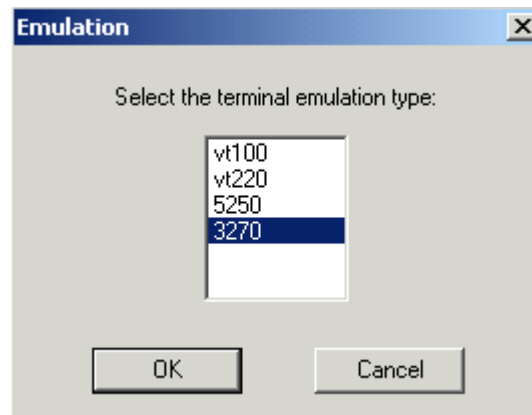

Click on **OK** after the selection is made, and return to the main Twin Client Manager menu. The standard settings tab will now reflect the settings for 3270 emulation.

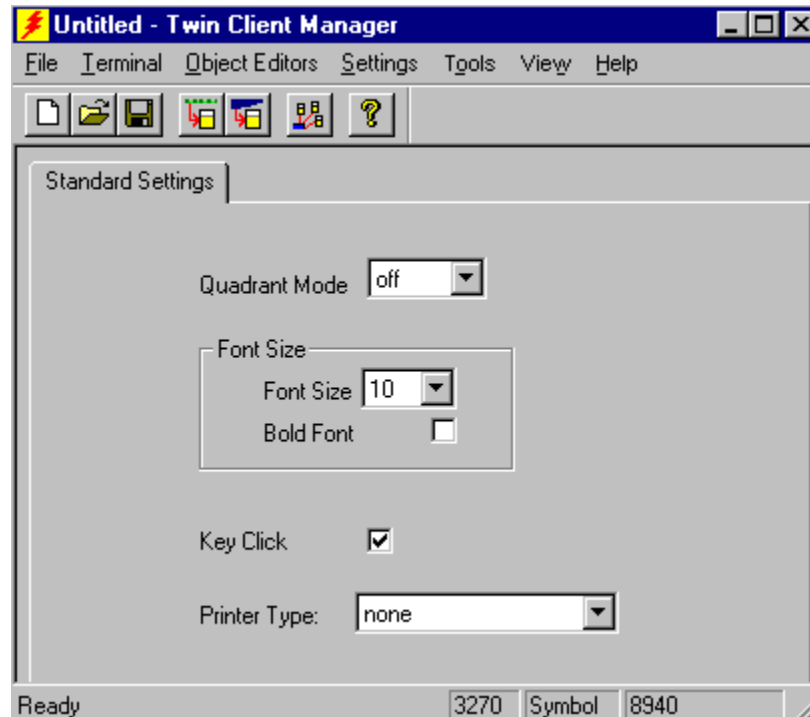

Quadrant Mode

This scrolling list option defines the rules by which the terminal display is positioned in the larger host display. As defined by Twin Client, quadrants are fixed position "windows" in the host display, and the terminal display is located on whatever quadrant contains the current cursor position.

Off disables quadrant processing and Twin Client simply centers the current host input field in the terminal display.

On enables quadrant processing. However, input fields that cross quadrant boundaries result in a shift to the left in order to locate as much of the current input field on the terminal display.

Soft always positions on a quadrant boundary regardless of input field boundaries. Viewing keys are enabled.

Hard is the same as **Soft** except the viewing keys are disabled.

Lock locks the terminal display origin (upper left corner) to fixed row and column (x,y) coordinates in the host display. The coordinates are zero-based.

Font Size and Bold Font

Font size has a scrolling list of font size options. Bold Font has a check box that enables (checked) or disables (unchecked) the display of characters in bold font.

Key Click

This check box enables (checked) or disables (unchecked) audible key clicks from the terminal. The default value is **on** (checked).

Printer Type

This scrolling list selects the attached printer type. The default value is **none**, indicating that no printer is attached.

Importing Custom Configurations

Existing installations that use a custom Symbol configuration file are easily converted to Twin Client with the **Import** option found under the **File** tab of Twin Client Manager.



Click on **Import**, and if necessary then click on the **Browse** button to locate the file.

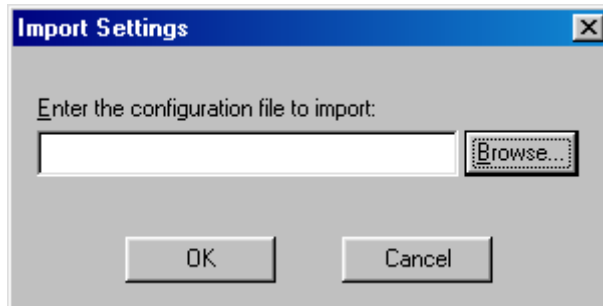

To further simplify conversion, the import utility displays all conversion errors and warnings so that potential compatibility problems can be easily identified and corrected.

Terminal Setup Using Twin Client Menus

The Twin Client terminal software provides an internal menu system for configuring certain parameters on the terminal and for switching between Server and Telnet mode of operation. To access this menu system, press uppercase **C** at the startup screen.

Twin Client
 © 1991-2006, Connect, Inc.
 Keypress to Continue

Note: The date of 2006 is updated on the terminal at the time of a new release.

The following menu appears in thick (Telnet) mode:

```
Edit Server/Host IPs
Edit License Key
Switch Client Modes
Run Client Emulator
Exit to OS
```

The following menu appears in thin (Server) mode:

```
Edit Server/Host IPs
Run Site Survey
Switch Client Modes
Run Client Emulator
Exit to OS
```

Use the **Up-Arrow** and **Down-Arrow** keys to navigate the menu, and press **Enter** to select the highlighted option. Each menu option is described below.

Edit Server/Host IPs

If the host IP address(es) were not pre-configured as described in the Setting the Servers section of *Configuring the Manager*, or if you wish to change those settings using the terminal menus, select this option and enter up to four Host IP addresses as required.

```
Host 0
IP 206.183.67.155
Port 23__
<F3> Save <F7> Quit
```

Press **F3** to save the configurations.

Edit License Key

The client software can be authorized automatically, as described in the next section, *Authorizing PowerNet*. This menu option permits authorization of each terminal manually. Select this option to obtain the terminal's Identification Code, used to obtain the Authorization code from the Connect web site, as described in the next section.

The 12-digit value displayed at the top of the terminal screen is the Identification Code for the terminal.

```
00A0F826E614
Authorization
_____
not authorized
<F3> Save <F7> Quit
```

Type the Authorization code into the field as it appears on the web site. Punctuation characters, such as the hyphen (-), are required. Press **F3** to save the Authorization code.

Run Site Survey

This option (a feature of Spectrum 1) is applicable to Release 5.0 and may be obsolete for your terminal.

Switch Client Modes

The PowerNet Twin Client normally operates in Telnet mode, which provides direct connection to Telnet hosts. It can also operate in Server mode, through a PowerNet OpenAir server. Select this menu option to switch between Server and Telnet modes of operation. Note that the host socket address for the PowerNet OpenAir servers is 1800, which must also be changed in the **Edit Server/Host IPs** menu described above.

Run Client Emulator

After all desired changes have been made, select this option to return to the Twin Client main menu. Then press any key to establish the Telnet session and begin emulation. Refer to *Starting a Telnet Session* for further instructions.

Authorizing PowerNet

Each PowerNet Twin Client will run for 30 minutes at a time without authorization. Uninterrupted operation for a production environment is the result of authorizing the software.

The Twin Client Manager can automatically authorize the terminal over the wireless network if the following requirements are met:

- A PC running Twin Client Manager is connected to the wire LAN segment with at least one access point within range of the terminal.
- The Airlod Hex file is installed on the terminal.
- The System ID of the PC on which Twin Client Manager is installed has been used to obtain a site license Authorization code from the Connect web site.

To obtain the System ID of the Twin Client Manager, click on the **A**uthorization option in the **T**ools menu, as shown below.

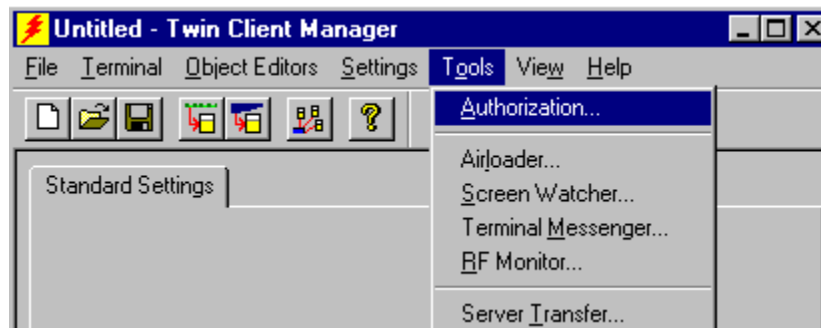

The Authorization window is displayed as shown below.

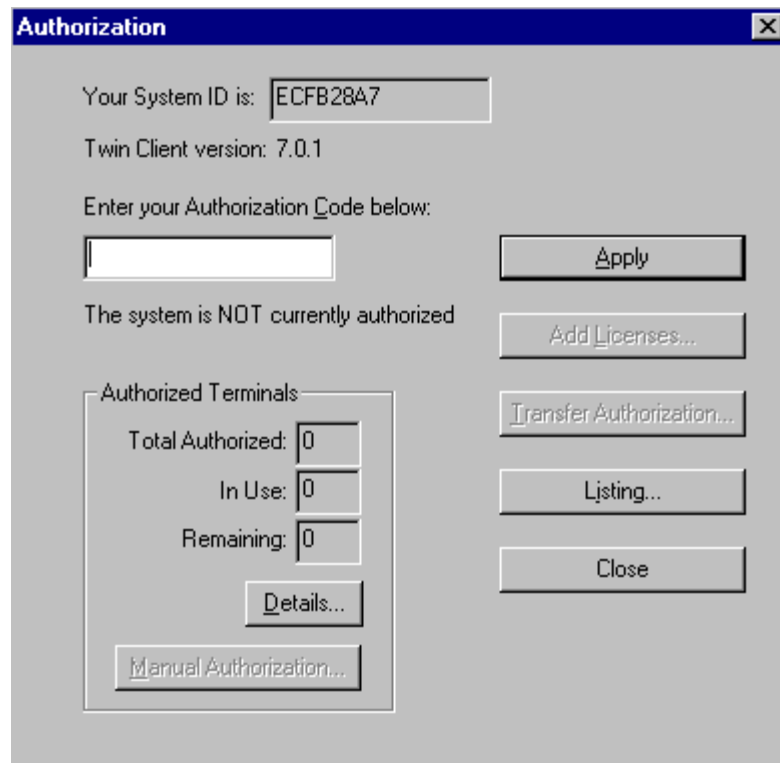

Go to <http://www.connectrf.com>. Click on **Partner Services**. Click on the **Generate Authorization** icon at the top of the page. Follow the directions on the web site.

Authorized Terminals

The number of terminals authorized, the number of terminals in use, and the number of terminals remaining is provided in the Authorized Terminals box on the lower left side of the screen.

Click on the **Details** button to number the options in the screen below in the order of your priority.

Note: The terminal may or may not be able to utilize the Formatter feature depending on its Authorization codes.

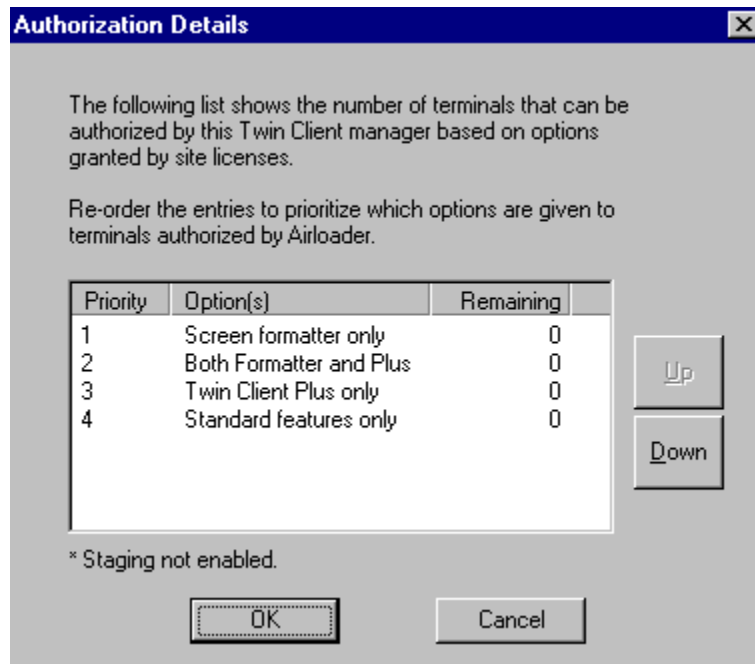

Click on an option and move it using the **Up** and **Down** buttons.

Click on **OK** when finished.

The **Manual Authorization** button is an alternate method of obtaining an Authorization code for a terminal. This method does not utilize Airloader, as does the other method.

Click on this button, manually enter your mac address in the screen that appears, and click on **OK**. This enables you to generate individual Authorization codes.

Add Licenses

The Add Licenses feature is used when adding additional licenses to an already site licensed Twin Client Manager.

An example of this is the instance in which Twin Client Manager is licensed for 10 licenses, and the customer purchases another 10 licenses to make a total of 20 licenses.

From Twin Client Manager, choose **Authorization** from under the **Tools** menu.

Click on the **Add Licenses** button.

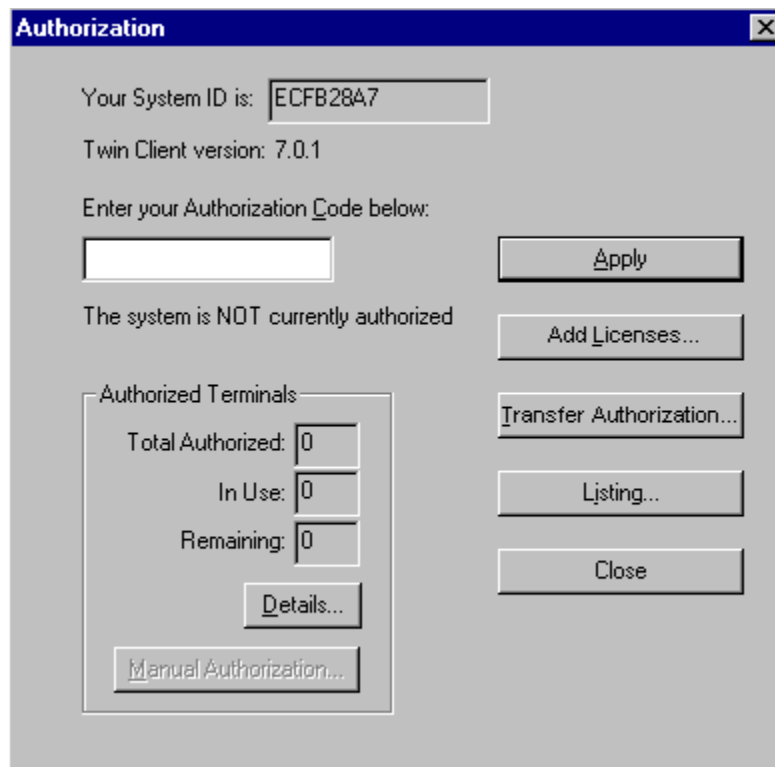

A pop-up box appears with the Machine ID and a space for the additional license's Authorization code.

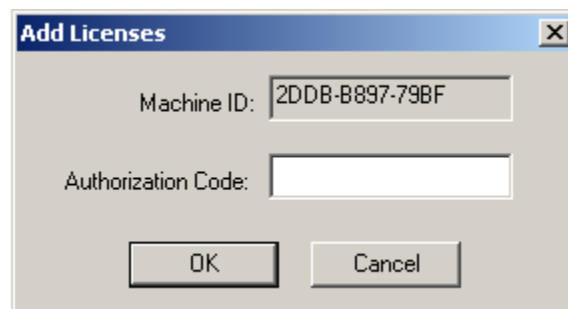

Enter the additional license's Authorization code and click on **OK**.

Use the Machine ID in the pop-up box instead of the original Machine ID to get your Authorization code.

If adding users, click on the Add Licenses button before generating the Authorization code to get the most current Machine ID.

Transfer Authorization

The Transfer Authorization feature is used when moving a site license from one PC to another.

After Twin Client Manager is installed on a new PC, you will need the System/Machine ID for it. This ID appears in the first box of the Authorization screen.

From Twin Client Manager, select **Authorization** from under the **Tools** menu.

Click on the **Transfer Authorization** button on the old PC.

You will be asked for the new System ID. Enter this new System ID. It will generate an Authorization code for the new PC's Twin Client Manager.

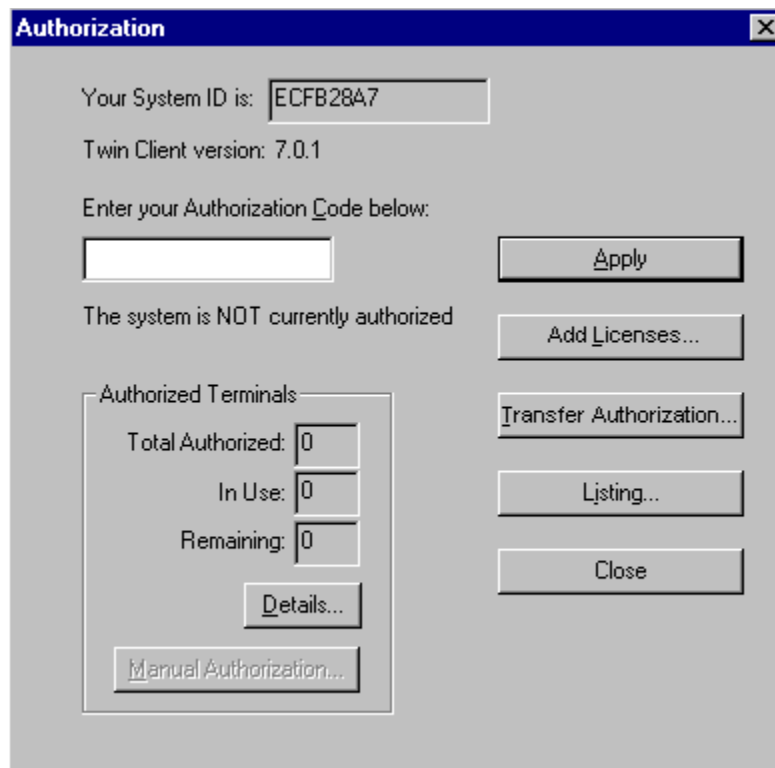

Note: This feature only works if there are licenses remaining on the old PC.

Listing

Click on the **Listing** button to view Authorization codes issued.

The Authorization codes used along with their corresponding serial numbers will appear.



Click on **OK** when finished.

Click on the **Close** button when finished.

Software Management

In addition to providing functions for the download of files to the terminal via the traditional serial connection, the Twin Client Manager also provides for the management of terminal software and configurations automatically over the wireless network. This section describes the automated capability in detail.

Airloader Auto-Configuration

The software and supporting configuration files for all Twin Client terminals can be configured for automated management after installing the Twin Client AirLoad Hex file in the terminals, as described in the section entitled *Quick Start*. The Airloader Auto-Configuration from is accessed from the Twin Client Manager **T**ools menu. Select **Airloader**.

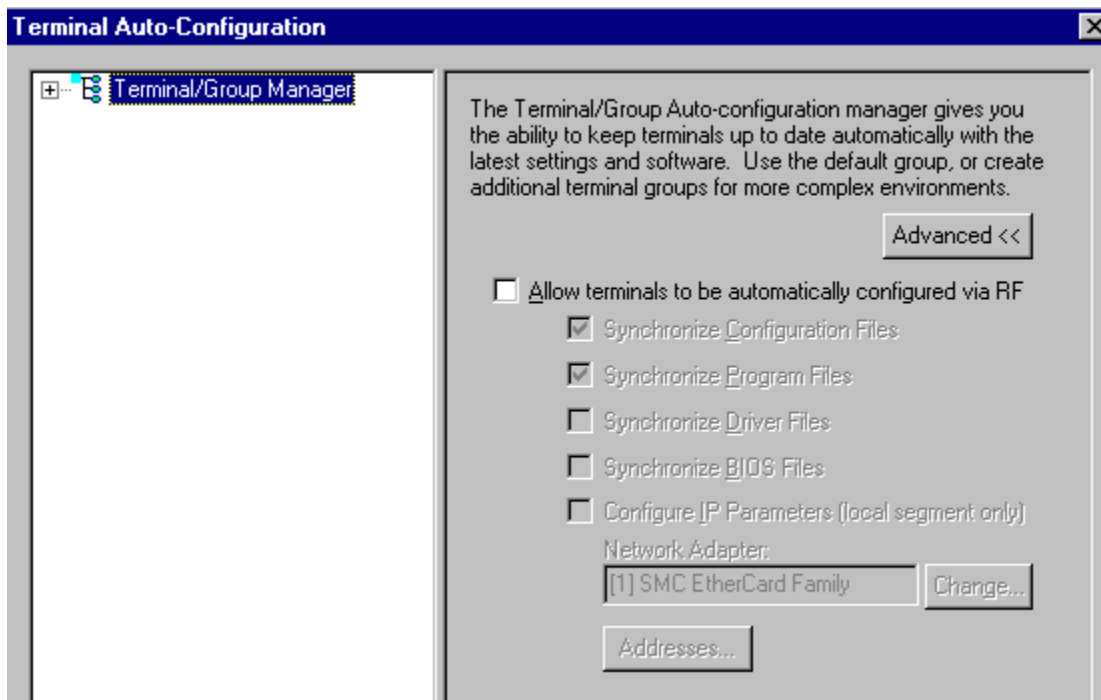

Note: If no options are displayed, click the **Advanced<<** button.

Enabling Automatic Downloads

Click to put a check in the box that allows terminals to be automatically configured via RF to enable automatic downloading. In the event that another PC on the network is already configured and active, the following warning message is displayed.

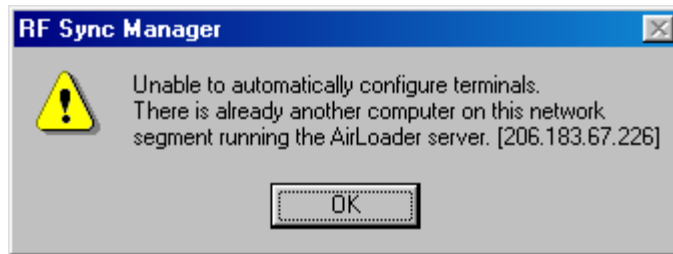

Synchronizing Configuration Files

Click to put a check in the Synchronize Configuration Files box to enable automatic synchronization of configuration files on the terminal. When the terminal is cold booted, its configuration files will be compared with the most recent on the PC. The terminal is updated automatically if it does not have the latest revision.

Synchronizing Program Files

Click to put a check in the Synchronize Program Files box to enable automatic synchronization of program files on the terminal. When the terminal is cold booted, its program files will be compared with the most recent on the PC. The terminal is updated automatically if it does not have the latest revision.

Automatic IP Address Assignment

An IP address does not need to be assigned to the terminal. The 8940 terminal can find the airloader server automatically.

Creating New Groups

New groups, with different configurations, can be created by clicking on **Terminal/Group Manager**, and then clicking the right mouse button as shown.



After the new group has been created, the group settings option becomes available for change, as shown below.

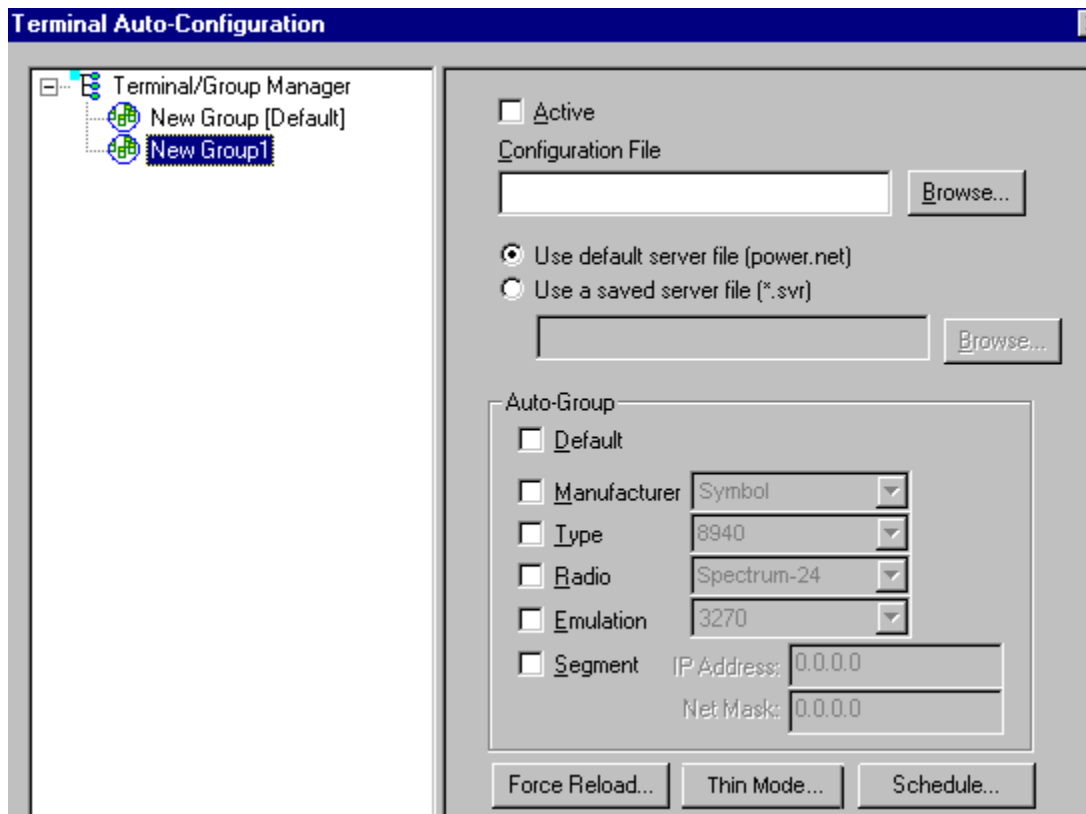

After the Configuration File and all of the other parameters have been set, the group is made active by clicking in the **Active** check box.

Note: A setting under the Group allows you to associate a saved server file (.svr file) with a particular group. This means that the .svr file will be sent to the terminal in place of the default power.net file. The .svr files are created in Twin Client Manager under Tools/Servers.

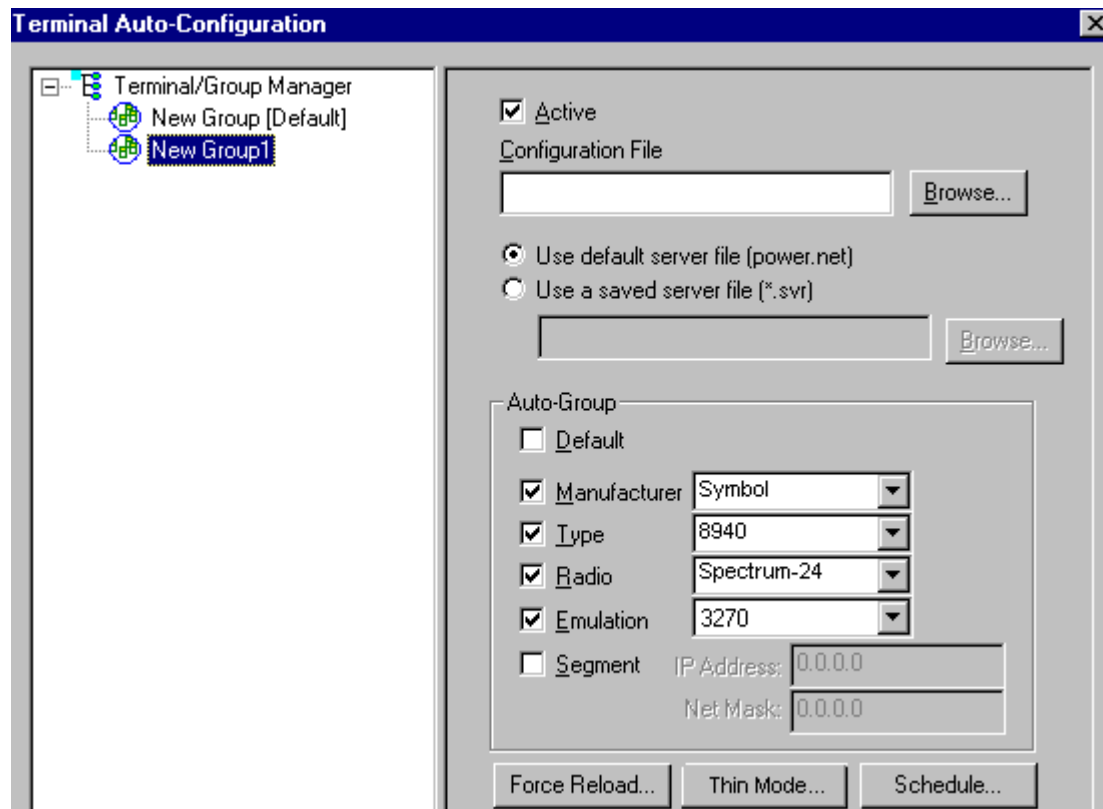

Clicking on the **Thin Mode** button will cause all terminals in this group that are currently running in thick mode to be switched to thin mode the next time Airloader is run on the terminal.

Click on the **Schedule** button to view a dialog box for scheduling an automatic Airloader update.

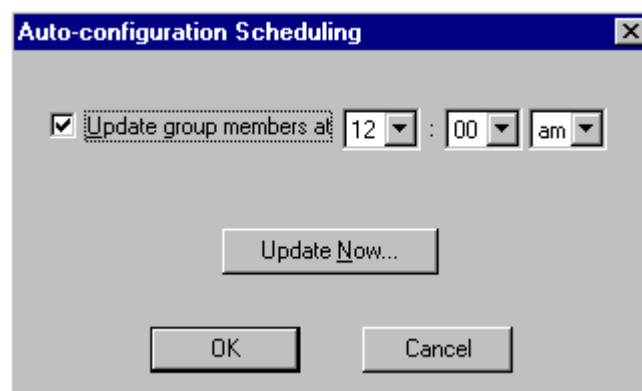

Select the desired time and click on **OK**. Click on **Update Now** to check all group members for updates.

Setting the Segment

Checking the **Segment** button restricts a terminal group to a range of IP addresses. The IP Address can be any valid address on the segment as it is used only to identify the segment. The setting of the Net Mask can be used to restrict the range. This feature is useful for segregating terminal groups by location.

Setting Force Reload

Clicking on the **Force Reload** button forces all terminals within a group to be automatically updated. The following warning message appears:

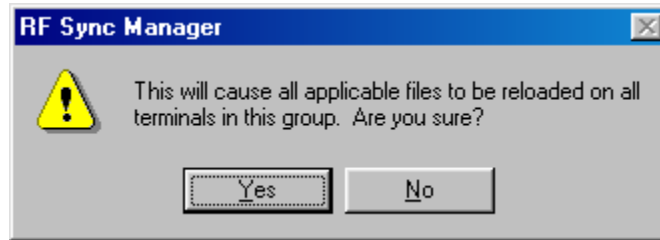

Click on the **Yes** button to force the reload.

Setting the Default Terminal Group

New terminals that have not yet been assigned to any group are initially assigned to the default group in effect when they are cold-booted.

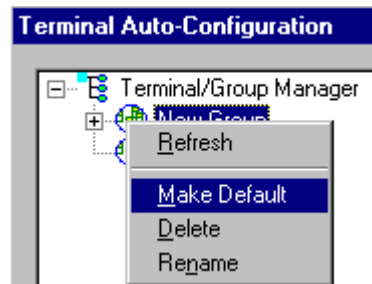

Any group can be made the default group by clicking on the group, and then clicking on the right mouse button. Then click on the **Make Default** option.

Reassigning Terminals

After a terminal has been configured and assigned to the default group, it can be reassigned to a new group by clicking on the terminal icon as shown below.

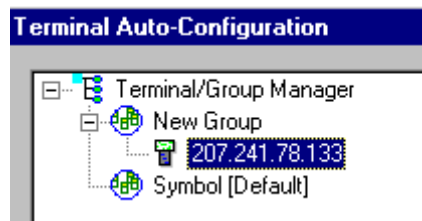

Then, holding the mouse button down, drag the terminal icon to the desired group as shown next.

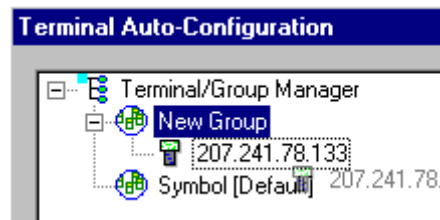

Release the mouse button, which reassigns the terminal.

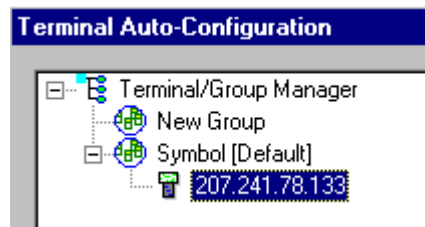

The next time the terminal is rebooted, it will be reconfigured as defined in the group specification.

Mobile Device Manager (MDM) Features

Under **Tools** in Twin Client Manager are the Screen Watcher, Terminal Messenger, and RF Monitor features.

Note: The terminal may or may not be able to utilize the Screen Watcher or Terminal Messenger features depending on its Authorization codes.

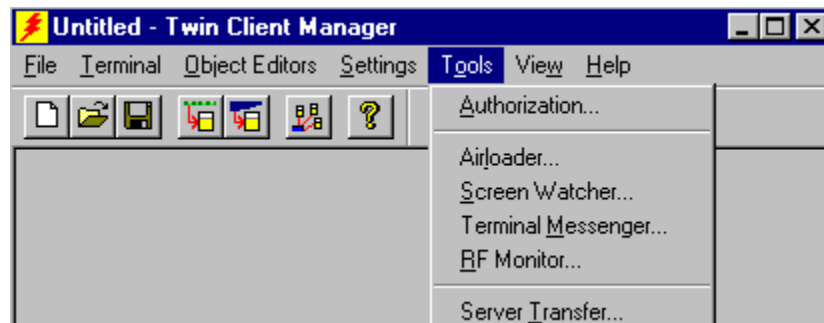

Select **Screen Watcher**, enter the terminal's IP address, and click on **OK**.

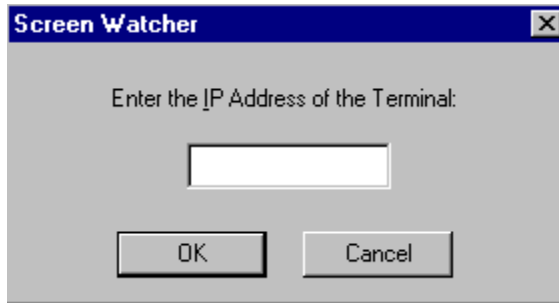

A screen will appear with a display resembling the terminal screen.

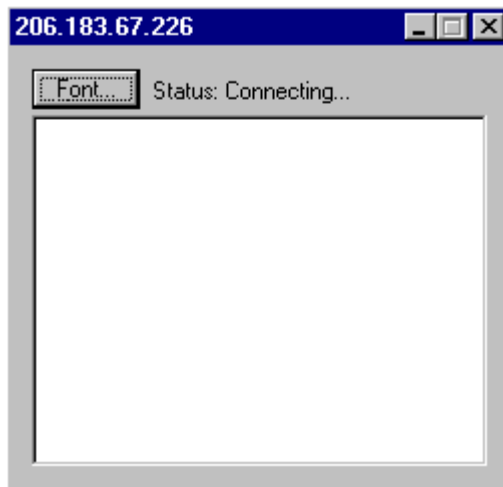

Clicking on the **Font** button on the upper left brings up a screen in which you can modify the font settings, as shown below.

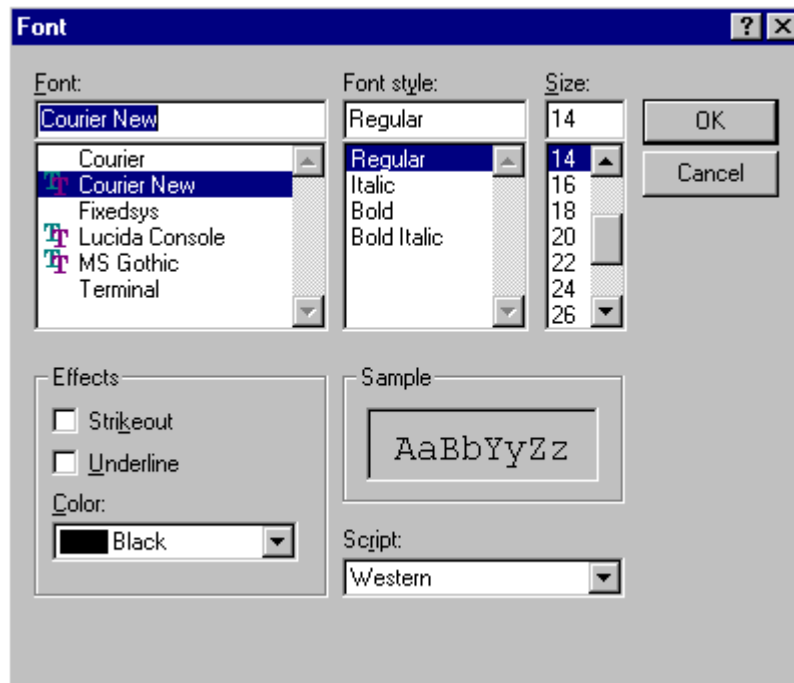

Select **Terminal Messenger** from the **Tools** menu.

You may enter an Address Range in the **From** and **To** boxes on this screen. Click on **Add** when finished.

Enter a message to send in the space provided, select the terminal to receive this message by clicking on it in the **Select Terminal(s)** column, and click on the **Send** button to send the message of your choice to the terminal of your choice.

See the example of the Terminal Messenger screen below.



To remove a terminal from the list of terminals receiving your message, click on the terminal number in the **Select Terminal(s)** column, and click on the **Remove** button. Click on the appropriate button, **Remove All**, **Select All**, or **Unselect All**, to remove all terminals, select all terminals, or unselect all terminals from the **Select Terminal(s)** list.

Note: Use the **Ctrl** and **Shift** keys to select multiple terminals.

Click on the **Close** button when finished.

Select **RF Monitor** from the **Tools** menu.

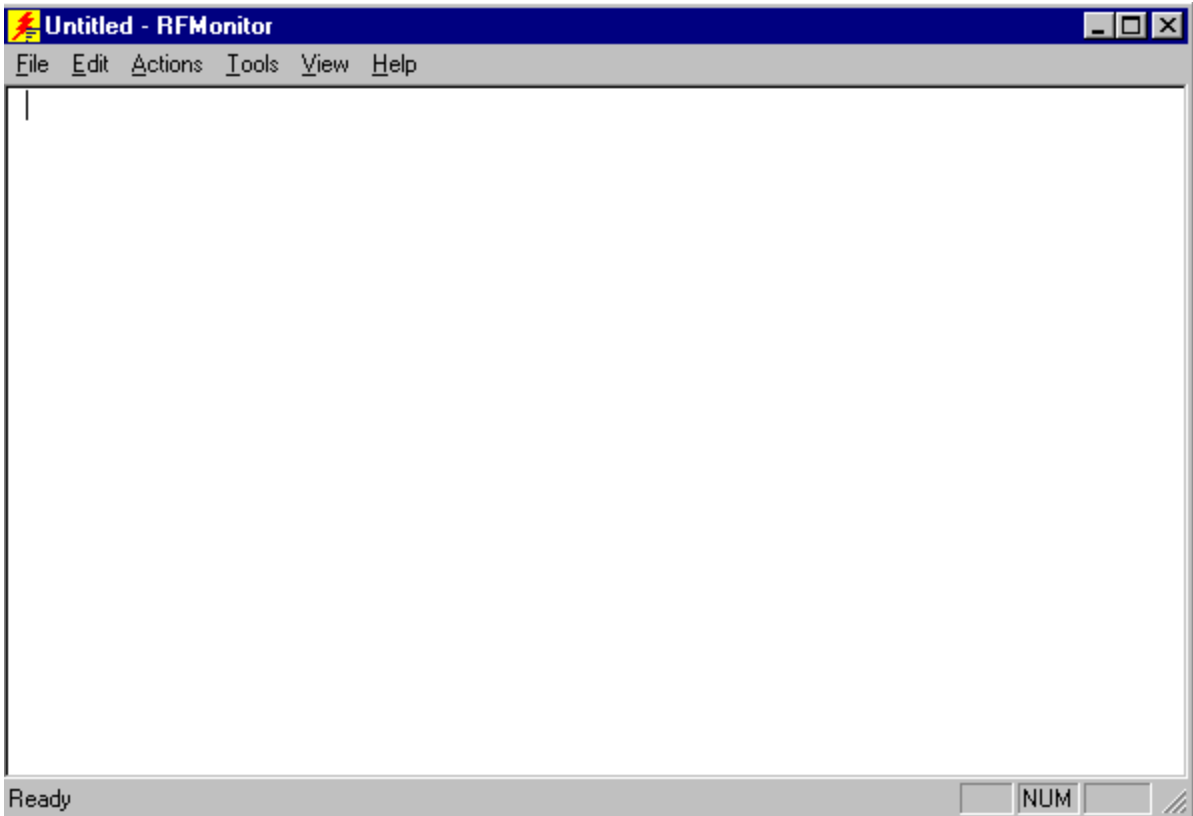

RF Monitor is an "Over The Air" diagnostic tool. It's used to collect diagnostic trace information from RF terminals running PowerNet Twin Client software.

It runs on a Windows PC and will send a command to the RF terminal to start tracing. The terminal, when it receives this command, will start sending the trace information over the RF link to the PC that issued the command. This will be written to a file on this PC that can be sent to us for analysis.

Click on **F**ile to **S**elect Terminal or to **E**xit.

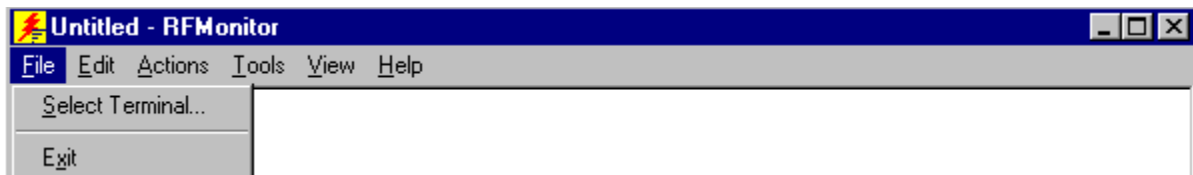

Choosing **S**elect Terminal allows you to view a log of the terminal's activity. Enter the Terminal IP address and Terminal IP Port, and click on **O**K.

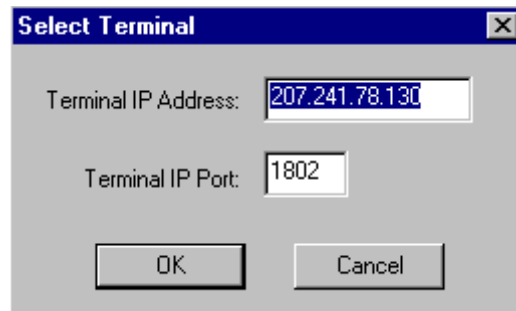

Click on **E**dit. Select Find, and/or Find Next to search for pieces of information in your log, or select Clear to clear the search.

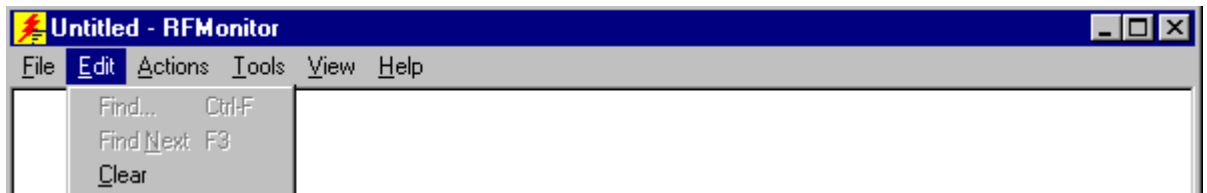

Click on **A**ctions to select Start Monitor or Stop Monitor.

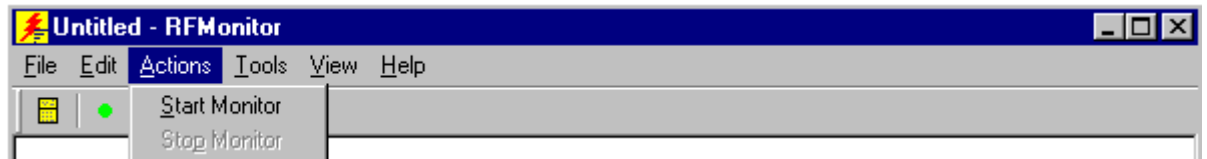

Click on **T**ools to choose Set Debug Levels or Settings.

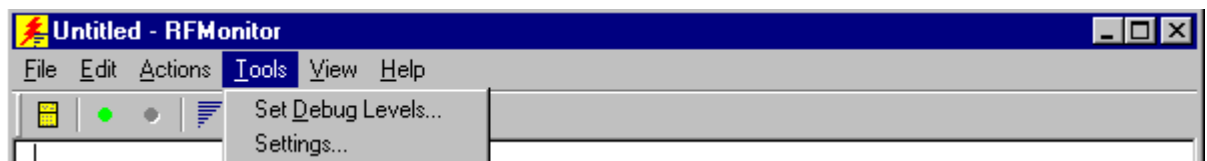

The options in Set Debug Levels are shown below.

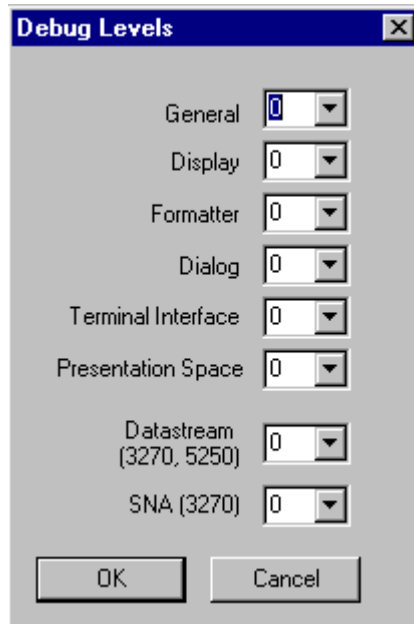

The maximum log file size can be set under Settings.

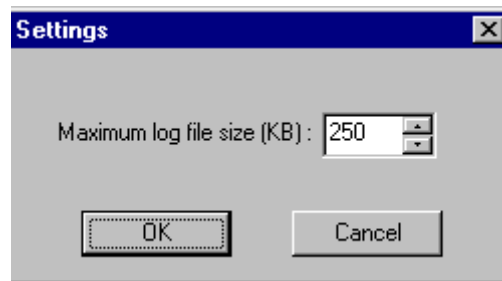

Click on **V**iew to show or hide the Toolbar and the Status Bar.

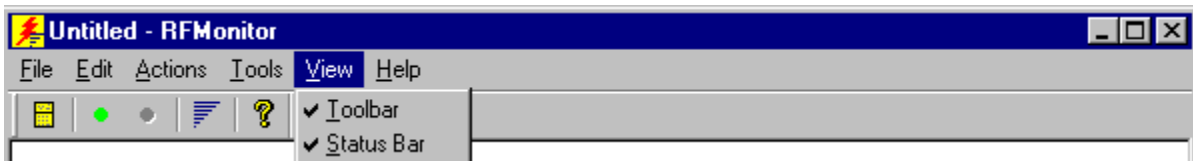

This is the Toolbar. It is found near the top of the screen.



This is the Status Bar. It is found at the bottom of the screen.



Click on **About RF Monitor** under **H**elp to view version number information. Click on **About Twin Client Manager** under **H**elp in the main menu to view the following screen.

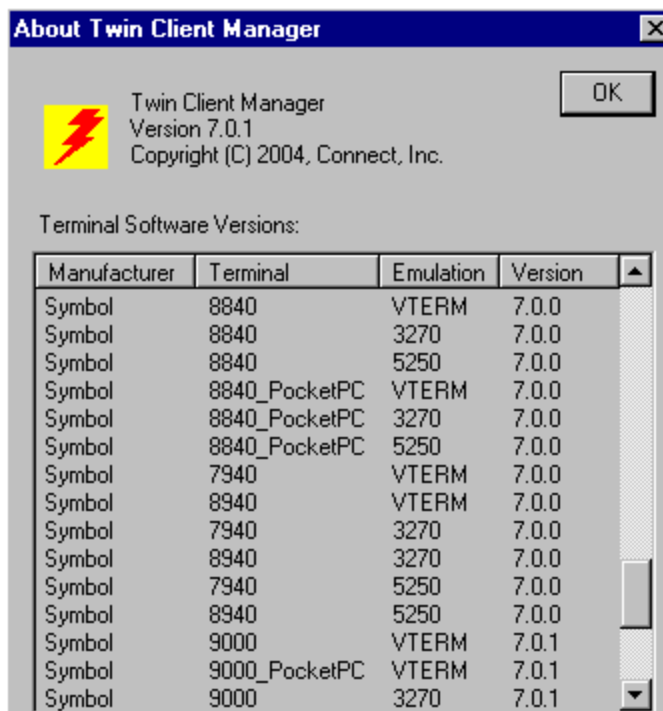

RF Monitor is a very small program and does not even require installation. Just place it in a directory on your PC and create a shortcut to run it. It will run on all versions of Windows except V3.1 and Windows 95.

1. Move RF Monitor to a Windows PC with Network access to the RF terminal.
2. Run RF Monitor. (Create a shortcut or do a **Start/Run**.)
3. From the pull down menu, select **File/Select Terminal**.
4. Key in the RF terminal IP address and leave the port at 1802.

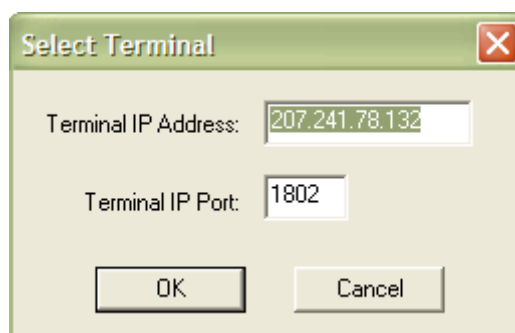

5. From the pull down menu, select **Tools/Set Debug Levels**. Set all levels to 9 except Datastream and SNA.

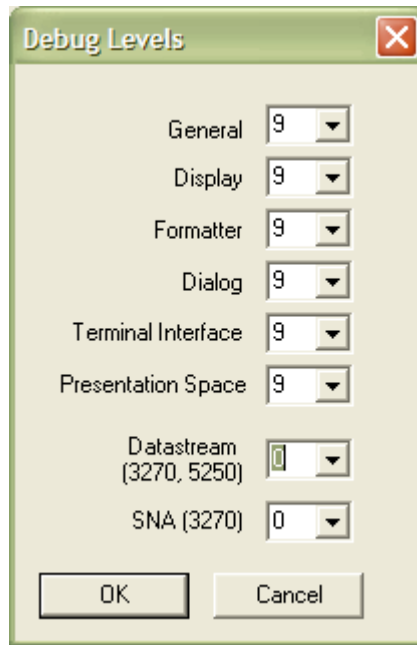

6. With the RF terminal sitting at the **Press Any Key** prompt, select **Actions/Start Monitor**.
7. Press a key on the RF terminal to open a session, and you should see trace data in the RF Monitor window. When done, end the trace and the file will be named **tnxxx.yyy.log** (where **xxx.yyy** is the last 2 octets of the RF terminal's IP address) in the directory in which RF Monitor was running.

```

08/11 11:57:55.000      0ms Log Started.
08/11 11:57:55.000      50ms BEGIN 5250 6.5.0 IBM-5291-1 TN E:\tnvt.cf
08/11 11:57:55.000     280ms TN_key=078.132< 0 vars (0)
08/11 11:57:55.000      50ms Dialog File: ''
08/11 11:57:55.000      0ms Dialog ''
08/11 11:57:57.000     1760ms Connected To: 207.241.78.5
08/11 11:57:57.000      60ms tip_snd: 2 bytes
51 00
08/11 11:57:57.000      50ms tip_rcv: 14 bytes
51 36 38 30 30 34 36 36 2E 33 2E 36 10 15      Q.
08/11 11:57:57.000      60ms tip_setup: model 6800 key 46 rev 630
08/11 11:57:57.000     160ms tip_snd: 137 bytes
5A 02 35 31 5A 02 41 31 5A 05 42 31 30 38 30 5A 2.512.A12.B10802
02 44 30 5A 05 46 33 32 34 30 5A 02 47 30 5A 02 .D02.F32402.G02.
49 04 5A 02 4D 31 5A 02 4E 30 5A 09 50 34 2C 33 I.Z.M12.N02.P4,3
32 2C 31 38 30 5A 02 51 31 5A 02 52 30 59 02 42 2,1802.Q12.R0Y.B
01 59 02 43 00 59 02 45 01 59 02 46 00 59 02 4A .Y.C.Y.E.Y.F.Y.J
00 59 02 49 01 58 03 42 00 00 58 02 46 0A 58 02 .Y.I.X.B..X.F.X.
47 00 58 08 48 65 6E 67 6C 69 73 68 5A 02 56 0A G.X.Henglish2.U.
5A 11 48 31 2C 31 35 30 2C 32 30 34 38 2C 33 30 Z.H1,150,2048,30

```

Common Problems with RF Monitor

- **The trace won't start.**

RF Monitor uses UDP to send commands to the RF device. On busy networks UDP packets are not always delivered. The terminal can miss the command to start the trace. Below are some things that can be useful.

- a. Ping the RF terminal from the PC used before starting RF Monitor. (This seems to "open" a path to the terminal.)
- b. Start the monitor with the terminal at the **Press Any Key** prompt. (While the terminal is at this prompt, it is not doing much and has a better chance of hearing the start trace command.)

- **I don't understand what this trace means.**

The trace that this tool collects is engineering level information. It allows an end user to collect information that can be analyzed by Connect engineering.

It will generally be requested by Connect support to help diagnose a reported problem.

To be able to read and understand these completely, you need to have an understanding of:

- a. Emulation protocols (IBM 5250, IBM 3270, DEC VT200, etc.)
- b. PowerNet Twin Client products
- c. RF Network concepts
- d. Wired network concepts
- e. Telnet sessions
- f. TCP/IP

They are text files that can be read with any editor or viewer and can be useful to end users and integrators even if they may not have all the requirements above.

- **I have an intermittent problem and it could happen on any one of my 100 terminals. RF Monitor only does one terminal at a time. What can I do?**

RF Monitor is not the right diagnostic tool for this type of problem. PowerNet products have another diagnostic tool that can be used called the "Diagnostic Server".

This tool can be set up to run trace diagnostics on up to 300 terminals at the same time. This tool will be provided as needed for systems under PowerNet support agreement OR by T&M when they are not covered.

It also includes the service of a PowerNet support engineer.

Server Transfer is another feature. From the **Tools** menu, select **Server Transfer**.

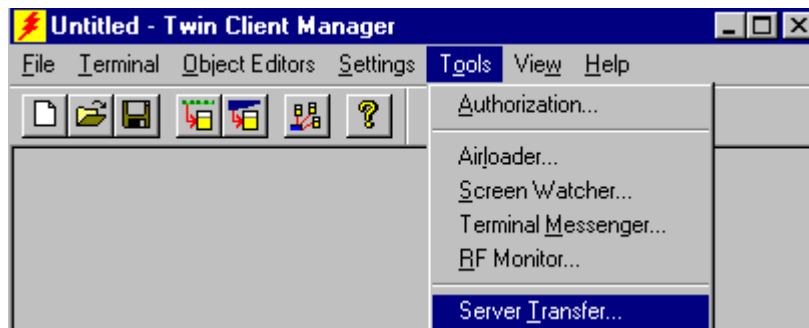

The FTP Settings screen appears.

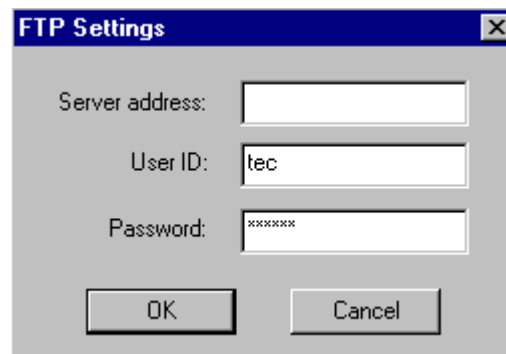

To send object editor and configuration files from Windows to your Linux box, enter your server address, and click on **OK**.

Sending Program and Configuration Files to the Terminal

1. Boot the terminal.
2. Go to **Start, Settings, and Control Panel**.
3. Double-click on the **Communications** icon.
4. Select the **PC Connection** tab.
5. Change the baud rate here if necessary.
6. Click on **OK**.
7. On the PC, choose **Connection Settings** from the **File** menu in ActiveSync.

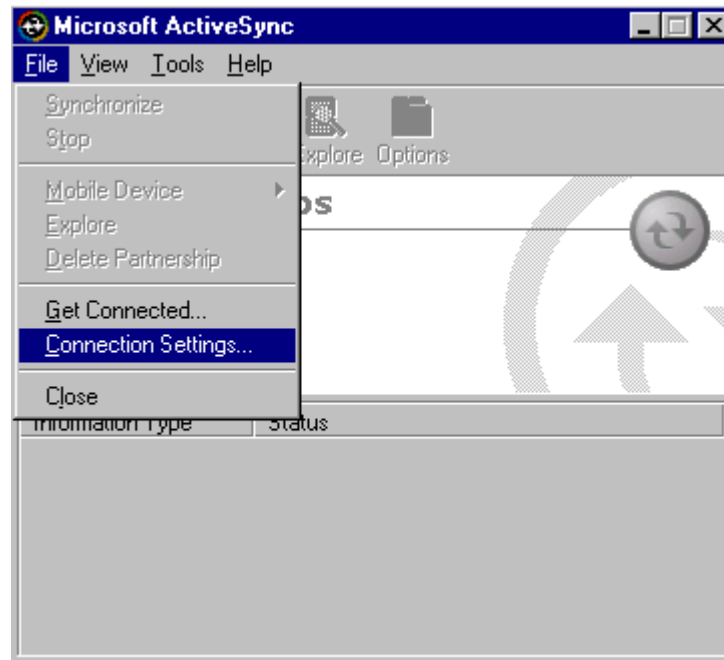

The **Connection Settings** screen appears as follows.

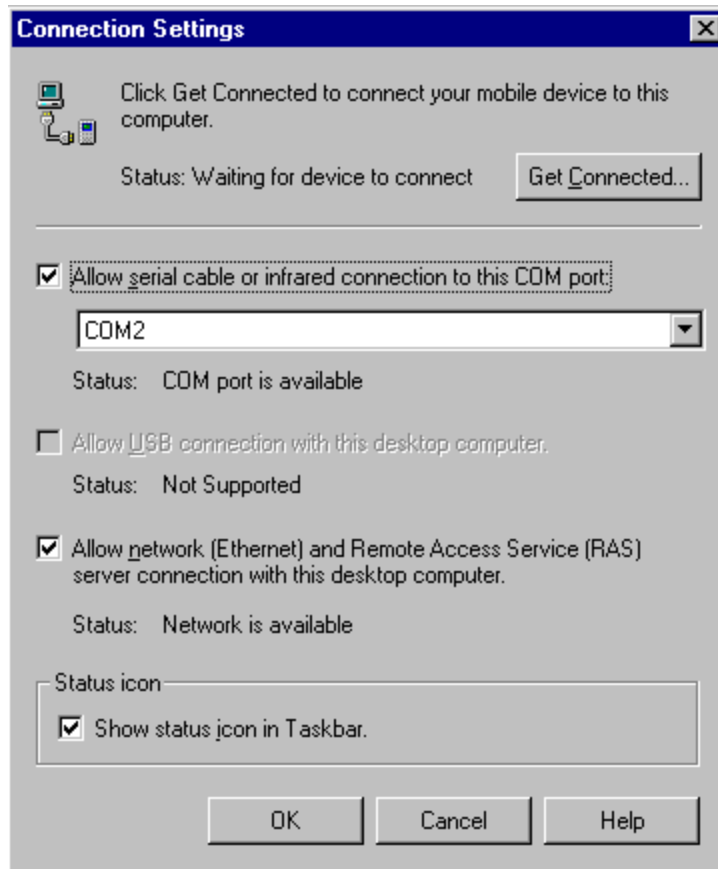

8. Make sure that the box is checked in front of the option entitled, **Allow serial cable or infrared connection to this COM port.**
9. Click on **OK**.

While ActiveSync is connecting, you will see the following screen.

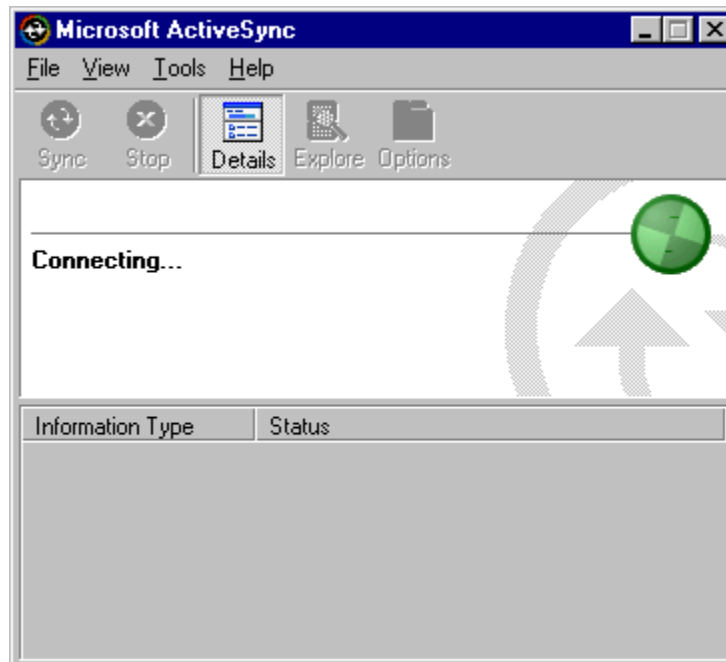

When ActiveSync has connected, you will see the screen below.



10. Select **No**, and then click **Next**.

The **Connected** screen appears.

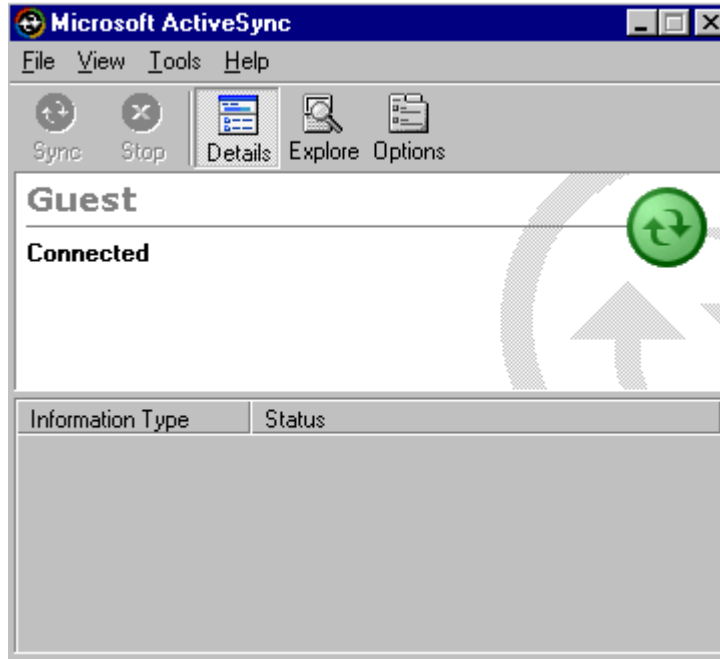

- On the PC, select **Send Program Files to Terminal** from the **Terminal** menu in Twin Client Manager.

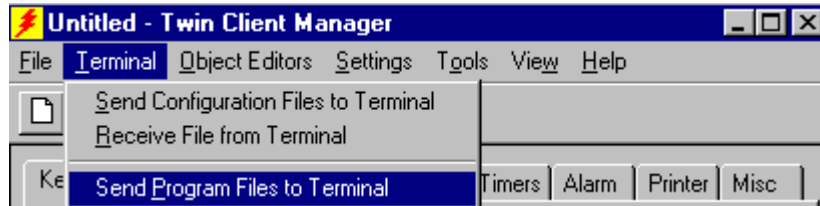

The following screen will appear.

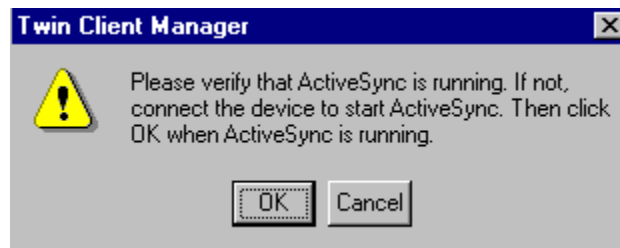

- Click on **OK**.

The following screen will appear.



13. Click on **OK**.
14. On the PC, choose **Send Configuration Files to Terminal** from the **Terminal** menu in Twin Client Manager.

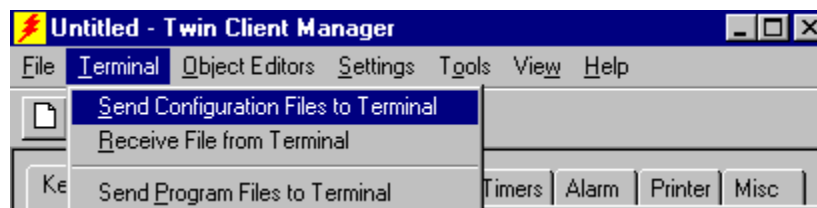

You will see the following screen.

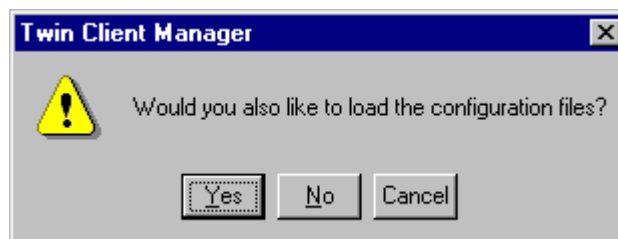

15. Choose **Yes**.

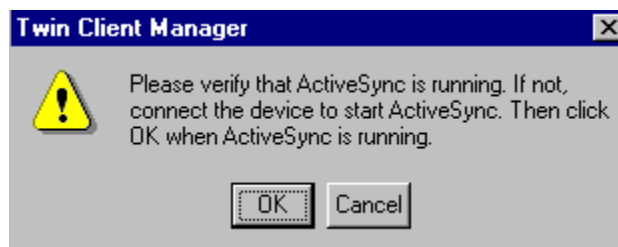

16. Click on **OK**.

The following screen will appear.



17. Click on **OK**.
18. On the terminal, select **Start, Settings, Control Panel, and Spectrum 24 Settings**.
19. Set the **ESS ID**.
20. Click on **OK**.
21. Click on **Start, Settings, and Control Panel, and Network**.
22. Select **Adapter** and click on **Properties**.
23. Set the **IP Address, Subnet Mask, and Default Gateway** or select **Obtain Address via DHCP**.
24. Click on **OK**.
25. Warm boot the terminal.

Chapter 3 • Keypad Configuration

Diagrams

VT emulation

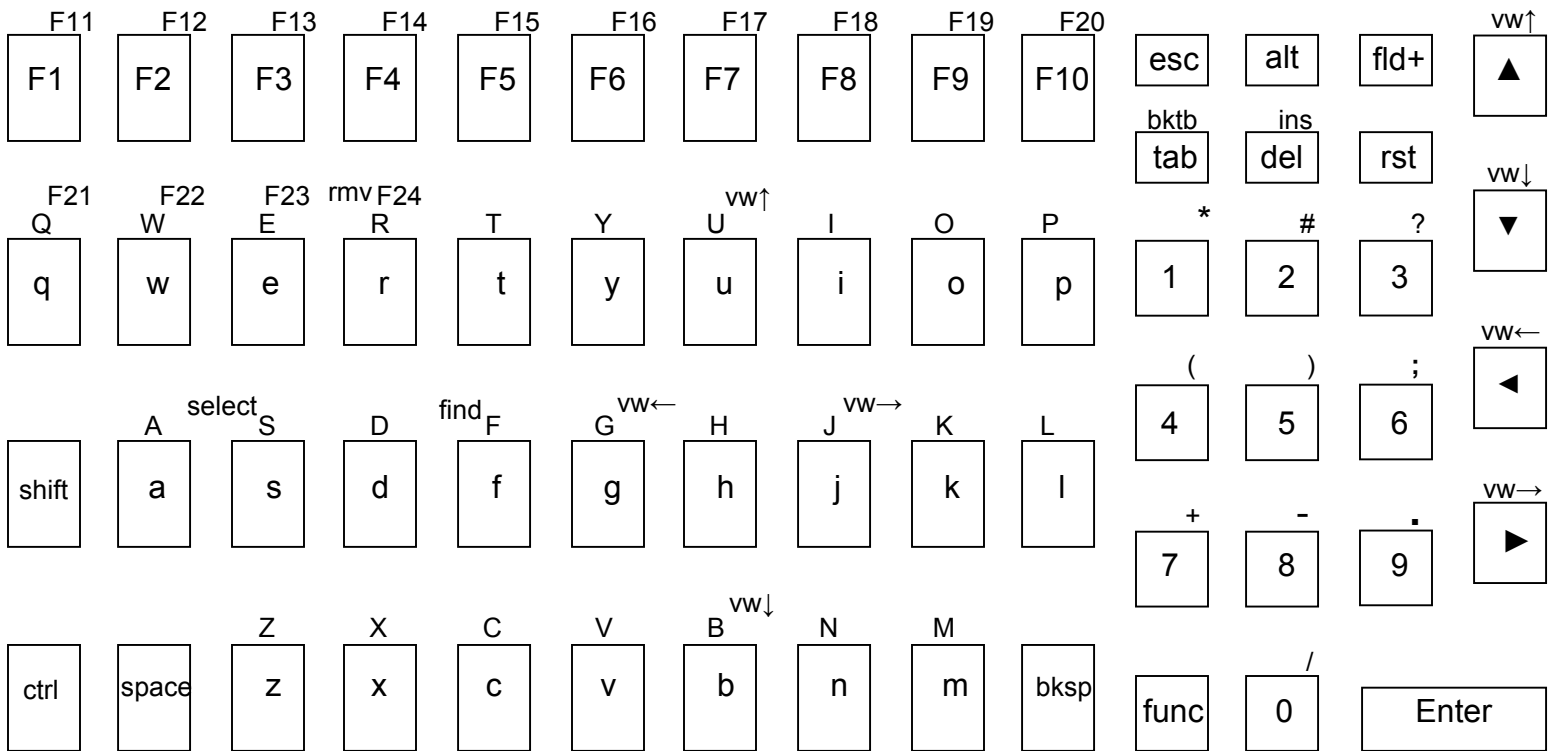

Ctrl Shift Func

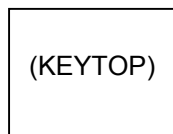

3270

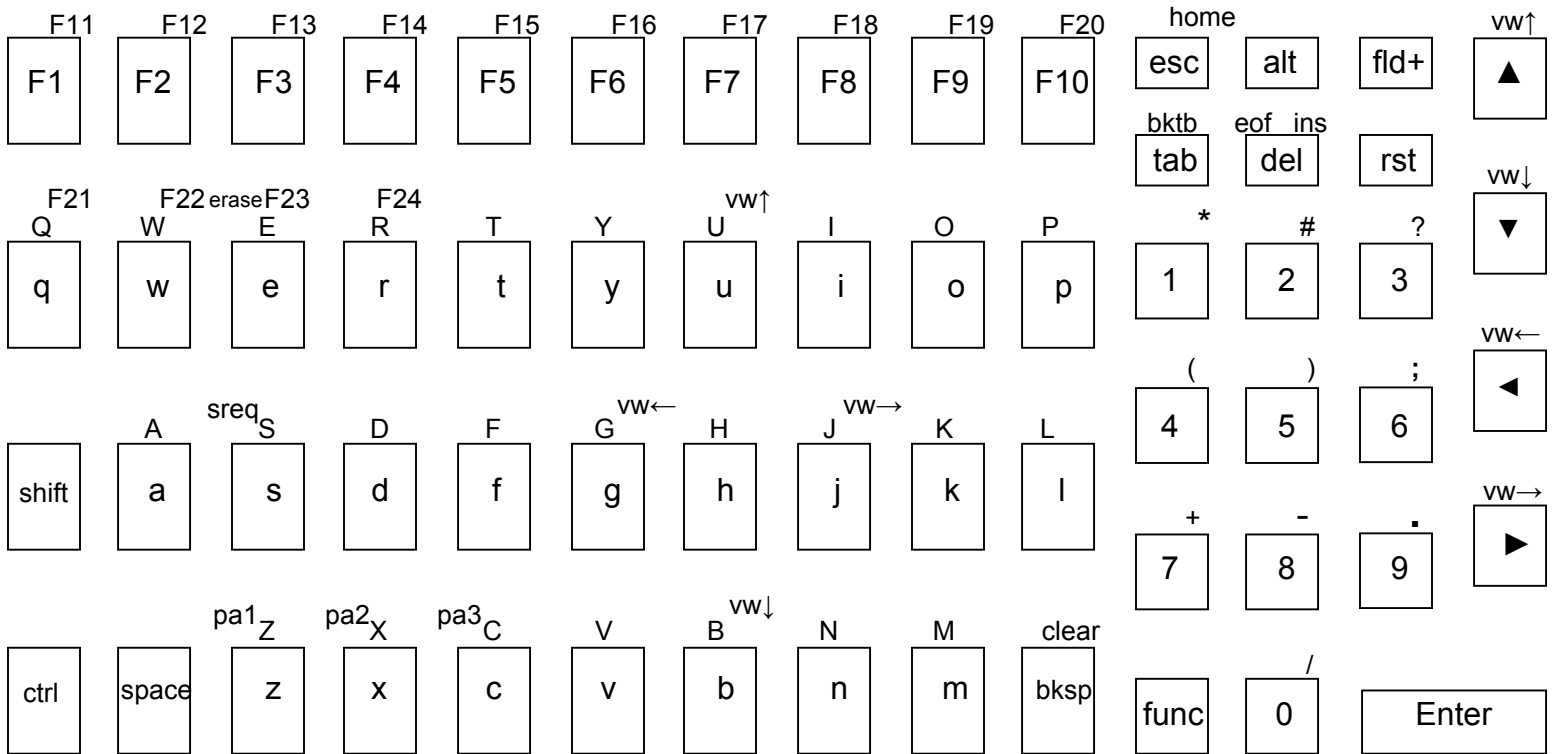

Ctrl Shift Func

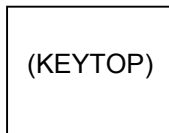

5250

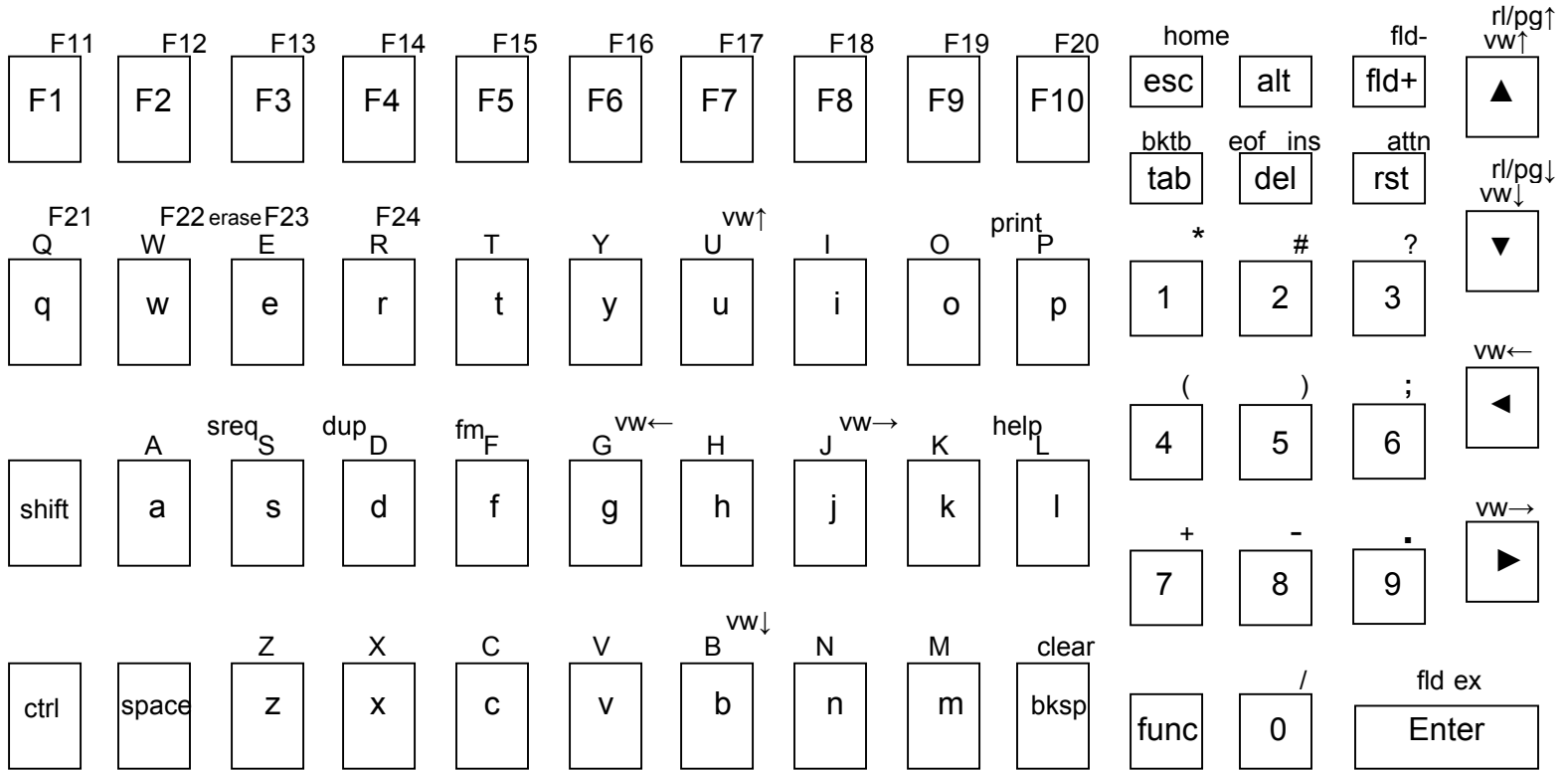

Ctrl Shift Func

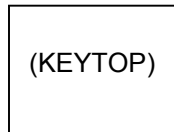

Table

Key	VTERM	3270	5250
a	<a>	<a>	<a>
b			
c	<c>	<c>	<c>
d	<d>	<d>	<d>
e	<e>	<e>	<e>
f	<f>	<f>	<f>
g	<g>	<g>	<g>
h	<h>	<h>	<h>
i	<i>	<i>	<i>
j	<j>	<j>	<j>
k	<k>	<k>	<k>
l	<l>	<l>	<l>
m	<m>	<m>	<m>
n	<n>	<n>	<n>
o	<o>	<o>	<o>
p	<p>	<p>	<p>
q	<q>	<q>	<q>
r	<r>	<r>	<r>
s	<s>	<s>	<s>
t	<t>	<t>	<t>
u	<u>	<u>	<u>
v	<v>	<v>	<v>
w	<w>	<w>	<w>
x	<x>	<x>	<x>
y	<y>	<y>	<y>
z	<z>	<z>	<z>
A	<Shift><a>	<Shift><a>	<Shift><a>
B	<Shift>	<Shift>	<Shift>
C	<Shift><c>	<Shift><c>	<Shift><c>
D	<Shift><d>	<Shift><d>	<Shift><d>
E	<Shift><e>	<Shift><e>	<Shift><e>
F	<Shift><f>	<Shift><f>	<Shift><f>
G	<Shift><g>	<Shift><g>	<Shift><g>
H	<Shift><h>	<Shift><h>	<Shift><h>
I	<Shift><i>	<Shift><i>	<Shift><i>
J	<Shift><j>	<Shift><j>	<Shift><j>
K	<Shift><k>	<Shift><k>	<Shift><k>
L	<Shift><l>	<Shift><l>	<Shift><l>
M	<Shift><m>	<Shift><m>	<Shift><m>
N	<Shift><n>	<Shift><n>	<Shift><n>
O	<Shift><o>	<Shift><o>	<Shift><o>
P	<Shift><p>	<Shift><p>	<Shift><p>
Q	<Shift><q>	<Shift><q>	<Shift><q>
R	<Shift><r>	<Shift><r>	<Shift><r>
S	<Shift><s>	<Shift><s>	<Shift><s>
T	<Shift><t>	<Shift><t>	<Shift><t>
U	<Shift><u>	<Shift><u>	<Shift><u>
V	<Shift><v>	<Shift><v>	<Shift><v>
W	<Shift><w>	<Shift><w>	<Shift><w>
X	<Shift><x>	<Shift><x>	<Shift><x>
Y	<Shift><y>	<Shift><y>	<Shift><y>
Z	<Shift><z>	<Shift><z>	<Shift><z>
Shift	<Shift>	<Shift>	<Shift>
Ctrl	<Ctrl>	<Ctrl>	<Ctrl>
Backspace	<Bksp>	<Bksp>	<Bksp>
Enter	<Enter>	<Enter>	<Enter>
Del			

Tab	<Tab>	<Tab>	<Tab>
Backtab	<Shift><Tab>	<Shift><Tab>	<Shift><Tab>
1	<1>	<1>	<1>
2	<2>	<2>	<2>
3	<3>	<3>	<3>
4	<4>	<4>	<4>
5	<5>	<5>	<5>
6	<6>	<6>	<6>
7	<7>	<7>	<7>
8	<8>	<8>	<8>
9	<9>	<9>	<9>
0	<0>	<0>	<0>
* asterisk	<Func><1>	<Func><1>	<Func><1>
# pound	<Func><2>	<Func><2>	<Func><2>
? question mark	<Func><3>	<Func><3>	<Func><3>
(left parenthesis	<Func><4>	<Func><4>	<Func><4>
) right parenthesis	<Func><5>	<Func><5>	<Func><5>
; semicolon	<Func><6>	<Func><6>	<Func><6>
+ addition sign	<Func><7>	<Func><7>	<Func><7>
- dash	<Func><8>	<Func><8>	<Func><8>
. period	<Func><9>	<Func><9>	<Func><9>
/ forward slash	<Func><0>	<Func><0>	<Func><0>
▲	<▲>	<▲>	<▲>
◀	<◀>	<◀>	<◀>
▼	<▼>	<▼>	<▼>
▶	<▶>	<▶>	<▶>
Insert	<Func>	<Func>	<Func>
Remove	<Ctrl><r>	---	---
Select	<Ctrl><s>	---	---
Home	---	<Func><Esc>	<Func><Esc>
Page Up	---	---	<Func><▲>
Page Down	---	---	<Func><▼>
Roll up	---	---	<Func><▲>
Roll down	---	---	<Func><▼>
View up	<Shift><▲>	<Shift><▲>	<Shift><▲>
View down	<Shift><▼>	<Shift><▼>	<Shift><▼>
View left	<Shift><◀>	<Shift><◀>	<Shift><◀>
View right	<Shift><▶>	<Shift><▶>	<Shift><▶>
PA1	---	<Ctrl><z>	---
PA2	---	<Ctrl><x>	---
PA3	---	<Ctrl><c>	---
Attention	---	---	<Func><Rst>
Clear	---	<Func><Bksp>	<Func><Bksp>
Field exit	---	---	<Shift><Enter>
FM	---	---	<Ctrl><f>
Help	---	---	<Ctrl><l>
EOF	---	<Ctrl>	<Ctrl>
Find	<Ctrl><f>	---	---
Field -	---	---	<Func><Fld+>
Field +	---	---	<Fld+>
Reset	---	<Rst>	<Rst>
Sys req	---	<Ctrl><s>	<Ctrl><s>
Print	---	---	<Ctrl><p>
Erase	---	<Ctrl><e>	<Ctrl><e>
Dup	---	---	<Ctrl><d>
F1	<F1>	<F1>	<F1>
F2	<F2>	<F2>	<F2>
F3	<F3>	<F3>	<F3>
F4	<F4>	<F4>	<F4>
F5	<F5>	<F5>	<F5>
F6	<F6>	<F6>	<F6>
F7	<F7>	<F7>	<F7>
F8	<F8>	<F8>	<F8>
F9	<F9>	<F9>	<F9>
F10	<F10>	<F10>	<F10>

F11	<Func><F1>	<Func><F1>	<Func><F1>
F12	<Func><F2>	<Func><F2>	<Func><F2>
F13	<Func><F3>	<Func><F3>	<Func><F3>
F14	<Func><F4>	<Func><F4>	<Func><F4>
F15	<Func><F5>	<Func><F5>	<Func><F5>
F16	<Func><F6>	<Func><F6>	<Func><F6>
F17	<Func><F7>	<Func><F7>	<Func><F7>
F18	<Func><F8>	<Func><F8>	<Func><F8>
F19	<Func><F9>	<Func><F9>	<Func><F9>
F20	<Func><F10>	<Func><F10>	<Func><F10>
F21	<Func><q>	<Func><q>	<Func><q>
F22	<Func><w>	<Func><w>	<Func><w>
F23	<Func><e>	<Func><e>	<Func><e>
F24	<Func><r>	<Func><r>	<Func><r>

Note: In order to utilize a modifier key (Shift, Ctrl, etc.), you must hold down the modifier key while pressing the second key.

Chapter 4 • Error Message Resolution Guide

Twin Client Error Message Resolution Guide

Message	Reason	Solution	Reference Tech Note
ENTRY TOO LONG;	Trying to key beyond the field size.	Ensure that you are entering input into the correct field.	---
ALPHABETIC ONLY;	Trying to key a character that is not alphabetic.	Ensure that you are entering input into the correct field.	---
MINUS NOT VALID;	Trying to key a Minus sign.	Ensure that you are entering input into the correct field.	---
DECIMAL NOT VALID;	Trying to key a Decimal (period).	Ensure that you are entering input into the correct field.	---
ALPHANUMERIC ONLY;	Trying to key characters other than Alphabetic and numeric.	Ensure that you are entering input into the correct field.	---
NUMERIC ONLY;	Trying to key characters other than numeric.	Ensure that you are entering input into the correct field.	---
ENTRY TOO SHORT;	Trying to exit the field before it is filled.	Ensure that you are entering input into the correct field.	---

Message	Reason	Solution	Reference Tech Note
INVALID KEY;	The key pressed is not valid.	Ensure that you are entering input into the correct field.	---
MUST CLEAR FIELD;	Trying to enter data in a field that must be cleared first.	Ensure that you are entering input into the correct field.	---
SCAN NOT ALLOWED;	Trying to scan into a key only field.	Ensure that you are entering input into the correct field.	---
KEY NOT ALLOWED;	Trying to key into a scan only field.	Ensure that you are entering input into the correct field.	---
ENTRY TOO SHORT;	Trying to exit the field before it is filled.	Ensure that you are entering input into the correct field.	---
RECOVERABLE ERROR;	Encountered an error from which you can continue.	Verify that your configuration settings for the hardware being used, usually a printer and cable issue.	---
UNRECOVERABLE ERROR;	Encountered an error from which you can NOT continue.	Verify that your Network settings are correct and you are in the correct mode using the correct Port.	T1113, T1114, T1161, T1171, T1187 and T1194
FUNCTION: \n\nFILE: \n\nLINE: \n\nCODE;	Encountered an error from which you can NOT continue.	Notify Connect over the Web incident reporting system.	---
Press any key\nFor More Details...;	Press Enter for more information.	Advisory message.	---
Press any key;	Press a key to continue.	Advisory message.	---

Message	Reason	Solution	Reference Tech Note
Connection ERROR.\nREBOOT MOBILE UNIT;	Could not Connect.	Verify that your Network settings are correct and you are in the correct mode using the correct Port.	T1113, T1114, T1161, T1171, T1187 and T1194
Disconnect ERROR.\nREBOOT MOBILE UNIT;	Could not Disconnect.	Verify that your Network settings are correct and you are in the correct mode using the correct Port.	T1113, T1114, T1161, T1171, T1187 and T1194
RF Send ERROR.\nREBOOT MOBILE UNIT;	Could not Send.	Most likely a range, access point, radio, host or network issue. Troubleshoot the customer's environment.	T1113, T1114, T1161, T1171, T1187 and T1194
RF Receive ERROR.\nREBOOT MOBILE UNIT;	Could not Receive.	Most likely a range, access point, radio, host or network issue. Troubleshoot the customer's environment.	T1113, T1114, T1161, T1171, T1187 and T1194
RF Check ERROR.\nREBOOT MOBILE UNIT;	Could not run the RF Survey.	Most likely a range, access point, radio, host or network issue. Troubleshoot the customer's environment.	T1113, T1114, T1161, T1171, T1187 and T1194
RF Timeout ERROR.\nREBOOT MOBILE UNIT;	Have been trying to contact the host for the radio timeout period (2 minutes default).	Most likely a range, access point, radio, host or network issue. Troubleshoot the customer's environment.	T1113, T1114, T1161, T1171, T1187 and T1194
REBOOT MOBILE UNIT;	Reboot the Mobile Unit do to loss of connection.	Most likely a range, access point, radio, host or network issue. Troubleshoot the customer's environment.	T1113, T1114, T1161, T1171, T1187 and T1194
Retry (Y/N)?;	Try again.	Try to send or receive again, or perhaps ensure that the printer is cabled to the Mobile Unit and is on.	---

Message	Reason	Solution	Reference Tech Note
TIMEOUT\n\nSending Data;	Mobile Unit out of the coverage area.	Most likely a range, access point, radio, host or network issue. Troubleshoot the customer's environment.	T1113, T1114, T1161, T1171, T1187 and T1194
TIMEOUT\n\nReceiving Data;	Mobile Unit out of the coverage area.	Most likely a range, access point, radio, host or network issue. Troubleshoot the customer's environment.	T1113, T1114, T1161, T1171, T1187 and T1194
Host Received Data\nAwaiting App Reply!;	Mobile Unit has sent and received an acknowledgement from the IP stack and is waiting for the application to return data.	Most likely a host or network issue. Troubleshoot the customer's environment. Probable causes are Database record locking, application program failure, Host failure or network failure.	T1113, T1114, T1161, T1171, T1187 and T1194
* WAITING TO SEND *;	Mobile Unit out of the coverage area.	Most likely a range, access point, radio, host or network issue. Troubleshoot the customer's environment.	T1113, T1114, T1161, T1171, T1187 and T1194
TCP Error Reading\nMAC Address.\nREBOOT MOBILE UNIT;	Could not obtain the Mac Address from the Mobile Unit.	Possible hardware, driver or stack problem Contact the Mobile Unit manufacturer.	---
Invalid TIP Command;	Bad internal protocol.	Notify Connect over the Web incident reporting system.	---
Session Ended\nBy User or Host;	User, Host, application or network has ended the session.	If the user did not end the session, most likely host or network issues. Troubleshoot the customer's environment.	T1113, T1114, T1161, T1171, T1187 and T1194
Server Packet Error;	Bad Protocol detected.	Usually a result of bad cabling, power or faulty transceiver. Also, will receive this if the Mobile Unit is in the wrong mode for server operation.	---

Message	Reason	Solution	Reference Tech Note
Error receiving host\nlist from Server;	Bad Protocol detected.	Usually a result of bad cabling, power or faulty transceiver. Also, will receive this if the Mobile Unit is in the wrong mode for server operation.	---
Unexpected Server\ndata received;	Bad Protocol detected.	Usually a result of bad cabling, power or faulty transceiver. Also, will receive this if the Mobile Unit is in the wrong mode for server operation.	---
Error starting\nhost application;	Connected to the server but can not connect to the distant end.	Configure the server handler to access the host application.	---
Select Host or App;	Need to choose your Host/application destination.	User selection required.	---
Connecting...;	Attempting to connect to the Host/application.	Advisory message.	---
TCP Error\nReading IP Address\nREBOOT MOBILE UNIT;	Mobile Unit missing Network IP information.	Configure the Mobile Unit with the correct network IP information.	---
Printer start error;	Could not initialize the printer.	Cable or power issue with the printer.	---
Battery too low\nto print;	Not enough power to print.	Replace the battery with a fully recharged battery.	---
Paper Feed Error\nFix Then Hit Enter;	Paper in the printer is not ready.	Replace the paper or rethread the paper in the printer.	---
Printer Error\nPrint Ended;	Can not print.	Check cable, battery, communication settings and paper in the printer.	---

Message	Reason	Solution	Reference Tech Note
User Count Exceeded.\n Session Ended;	Possible authorization issue.	Verify that you have the correct number of licenses for the number of Mobile Units you are using.	---
Primary Unavailable\nTrying Alternate;	First Host IP address not available trying the remaining addresses in the Host list.	Verify the host address.	---
APMAC.DAT Error\nSession Ended;	Access point Media Access Control error.	Most likely a range, access point, radio, host or network issue. Troubleshoot the customer's environment.	T1113, T1114, T1161, T1171, T1187 and T1194
MUIP.DAT Error\nSession Ended;	Mobile Unit IP Error.	Most likely a Mobile Unit network setting issue. Troubleshoot the customer's environment.	T1113, T1114, T1161, T1171, T1187 and T1194
Missing Subnet IP\nSession Ended;	Mobile Unit IP Netmask Error.	Most likely a Mobile Unit network setting issue. Troubleshoot the customer's environment.	T1113, T1114, T1161, T1171, T1187 and T1194
Error Opening File;	File is missing.	Verify that the configuration files are on the Mobile Unit. Or perhaps there is a hardware failure.	---
Telnet API\nnot found;	Program files are missing.	Reload program files.	---
Battery Low Warning\n\nReplace Battery Soon;	Not enough power to operate the Mobile Unit.	Replace the battery with a fully recharged battery.	---
No Host List.\nPress any key\nTo Edit Host IP's;	Have not configured your target hosts.	Configure the target host IP addresses.	---

Message	Reason	Solution	Reference Tech Note
Unable to Allocate\nFont Memory;	Mobile Unit does not have enough memory to load the fonts.	Reduce the fonts in use or expand the memory in the Mobile Unit.	---
Font Loading Error;	Could not load the font.	Ensure that the font is available to load.	---
Printer Not Ready\nPress R to Retry\nC to Cancel Print;	Can not print.	Check cable, battery, communication settings and paper in the printer.	---
Mobile Unit in\nDemonstration Mode\nfor TwinClient;	Running in demo mode.	Purchase a license from Connect.	---
Connected to Host;	Successful connection to the target Host.	Advisory message.	---
Telnet Mode not\nsupported on\nthis Mobile Unit;	This Mobile Unit must be used with a Connect Server.	Order a Connect Server.	---
Telnet Setup files\nnot found. Reload\nfiles then switch;	Customer specific configuration files are missing.	Load the configuration files into the Mobile Unit from Twin Client Manager.	---
Switched Client to\nTelnet Direct Mode;	Mobile Unit running in Telnet mode direct to the target Host.	Advisory message.	---
Switched Client to\nServer Based Mode;	Mobile Unit running through a Connect server in Server mode usually at port 1800.	Advisory message.	---
Port 23 is only\nallowed in Telnet Mode;	Can not set the port to 23 in Server mode. Port 23 is the standard Telnet port.	Advisory message.	---
Not Enough Memory\nTo Run;	Mobile Unit does not have the capacity to run the program do to memory restrictions.	Expand the Mobile Unit memory.	---

Message	Reason	Solution	Reference Tech Note
Press any key;	Press a key to continue.	Advisory message.	---
TwinClient Telnet;	Prompt.	Advisory message.	---
TwinClient Server;	Prompt.	Advisory message.	---
TwinClient TN3270;	Prompt.	Advisory message.	---
TwinClient TN5250;	Prompt.	Advisory message.	---
TwinClient TNVT;	Prompt.	Advisory message.	---
(c) 1991-2006 Connect;	Prompt.	Advisory message.	---
Edit Menu Options;	Menu Title.	Advisory message.	---
Edit Mobile Unit IP;	Menu Option.	Advisory message.	---
Edit Server/Host IPs;	Menu Option.	Advisory message.	---

Message	Reason	Solution	Reference Tech Note
Edit Radio Option;	Menu Option.	Advisory message.	---
Edit License Key;	Menu Option.	Advisory message.	---
Run Site Survey;	Menu Option.	Advisory message.	---
Switch Client Modes;	Menu Option.	Advisory message.	---
Run TwinClient;	Menu Option.	Advisory message.	---
Exit to OS;	Menu Option.	Advisory message.	---
Printer may not be plugged in or returned on!;	Can not print.	Check cable, battery, communication settings and paper in the printer.	---
OUT OF RANGE OF BASE;	Mobile Unit out of the coverage area.	Most likely a range, access point, radio, host or network issue. Troubleshoot the customer's environment.	T1113, T1114, T1161, T1171, T1187 and T1194
CONNECT SERIAL CABLE;	Serial cable not connected to the Mobile Unit.	Check cable, battery and communication settings for the Mobile Unit.	---
REMOVE SERIAL CABLE;	Remove serial cable from to the Mobile Unit.	Check cable, battery and communication settings for the Mobile Unit.	---

Message	Reason	Solution	Reference Tech Note
PLACE IN CRADLE;	Place the Mobile Unit in the cradle.	Advisory message.	---
REMOVE FROM CRADLE;	Remove Mobile Unit from the cradle.	Advisory message.	---
ACQUIRING CRADLE BUS;	Attempting to access the cradle through the serial port you have configured.	Advisory message.	---
Printer Out\nOf Range;	Printer out of the coverage area.	Most likely a range, access point or radio issue. Troubleshoot the customer's environment.	T1113, T1114, T1161, T1171, T1187 and T1194
Connection Refused\nBy Host;	You connected to the target host but the host disconnected you.	Verify that the configuration file has the correct Mobile Unit type and New environment variable set. Fallback to the Connect Default to verify the connection.	---
Connection Timed Out;	You connected to the host but did not logon in the appropriate time so the host disconnected you.	Modify the Host parameters for login.	---
Connection Failed\nHost Not Responding;	Could not connect to the Host.	Most likely a range, access point, radio, host or network issue. Troubleshoot the customer's environment.	T1113, T1114, T1161, T1171, T1187 and T1194
Connection Failed\nHost Unreachable;	Could not connect to the Host.	Most likely a range, access point, radio, host or network issue. Troubleshoot the customer's environment.	T1113, T1114, T1161, T1171, T1187 and T1194
Mobile Unit Out\nOf Range, Unable\nTo Transmit;	Mobile Unit out of the coverage area.	Most likely a range, access point, radio, host or network issue. Troubleshoot the customer's environment.	T1113, T1114, T1161, T1171, T1187 and T1194

Message	Reason	Solution	Reference Tech Note
Mobile Unit Out\nOf Range, Unable\nTo Receive;	Mobile Unit out of the coverage area.	Most likely a range, access point, radio, host or network issue. Troubleshoot the customer's environment.	---
Printer Not\nResponding;	Can not print.	Check cable, battery, communication settings and paper in the printer.	---
Printer Out\nOf Range;	Printer out of the coverage area.	Most likely a range, access point or radio issue. Troubleshoot the customer's environment.	T1113, T1114, T1161, T1171, T1187 and T1194
Print Complete;	Prompt.	Advisory message.	---
Reprint (Y/N)?;	Yes or No prompt for a reprint.	Advisory message.	---
WARNING;	Prompt.	Advisory message.	---
Turning power off\nduring a session\nwill cause the\nprogram to restart;	This Mobile Unit will disconnect the session if powered off.	Mobile Unit manufacturer limitation. Advisory message.	---
Are you sure (y/n)?;	Yes or No prompt for a confirmation.	Advisory message.	---
You Sure? (YyNn);	Yes or No prompt for a confirmation.	Advisory message.	---

Message	Reason	Solution	Reference Tech Note
Domain Name Server\nNot Set;	DOMAIN NAME SERVER not configured.	Configure the Mobile Unit with the correct network IP information.	---
Domain Name Server\nQuery Memory Error;	Memory error on the Mobile Unit	Expand the Mobile Unit memory or return the Mobile Unit for repair.	---
Domain Name Server\nQuery Sending Error;	Mobile Unit out of the coverage area.	Most likely a range, access point, radio, host or network issue. Troubleshoot the customer's environment.	T1113, T1114, T1161, T1171, T1187 and T1194
Domain Name Server\nQuery Receive Error;	Mobile Unit out of the coverage area.	Most likely a range, access point, radio, host or network issue. Troubleshoot the customer's environment.	T1113, T1114, T1161, T1171, T1187 and T1194
Domain Name Server\nUnavailable;	Could not connect to the DOMAIN NAME SERVER.	Most likely a range, access point, radio, host or network issue. Troubleshoot the customer's environment.	T1113, T1114, T1161, T1171, T1187 and T1194
Error loading\nparameter file;	Could not load the parameter file.	Reload the correct configuration files.	---
Could not open\nTelnet interface;	Could not Telnet.	Reload the program files.	---
Could not set\nTelnet options;	Could not use the Telnet configuration.	Reload the correct configuration files.	---
Setup file\nsetting mismatch\nReload Setup;	Emulation program selected is not compatible with the configuration file on the Mobile Unit.	Remove the emulation and configuration files. Run clear Telnet on the Mobile Unit then reload the Mobile Unit with the proper emulation and configuration files.	---

Message	Reason	Solution	Reference Tech Note
Display formatting\ntoo large for\ncurrent screen;	Mobile Unit does not have enough memory to run your configured reformatted screens.	Expand the Mobile Unit memory or order a server from Connect.	---
Mobile Unit\ninitialization error;	Mobile Unit problem.	Return the Mobile Unit to the manufacturer for repair.	---
Host/App/Network\nclosed the session;	Customer's environment disconnected the Mobile Unit session.	Most likely a range, access point, radio, host or network issue. Troubleshoot the customer's environment.	T1113, T1114, T1161, T1171, T1187 and T1194
Disconnecting...;	Prompt.	Advisory message.	---
Scan Barcode;	Bar code scanning test.	Advisory message.	---
Enter Setup\nPassword;	Prompt.	Advisory message.	---
Enter Profile \nPassword;	Prompt.	Advisory message.	---
Host IP;	Host IP address prompt.	Enter target host IP address.	---
Host Name;	Host name prompt.	Enter target host Name.	---
Port;	Host IP port required.	Enter 23 for Telnet or 1800 for a Connect server. Could also be a different number depending on the customer's environment.	T1113, T1114, T1161, T1171, T1187 and T1194

Message	Reason	Solution	Reference Tech Note
Mobile Unit Type;	Prompt.	Advisory message.	---
WARNING: This will \nend any\ncurrent session;	Prompt.	Advisory message.	---
Continue (Y/N)?;	Prompt.	Advisory message.	---
HOST ENTRY;	Prompt.	Advisory message.	---
VT(100/220) Setup;	Prompt.	Advisory message.	---
Mobile Unit Info;	Prompt.	Advisory message.	---
Emulation Setup;	Prompt.	Advisory message.	---
ANSI Setup;	Prompt.	Advisory message.	---
Miscellaneous Setup;	Prompt.	Advisory message.	---
Mobile Unit Type;	Prompt.	Advisory message.	---

Message	Reason	Solution	Reference Tech Note
Control Codes;	Prompt.	Advisory message.	---
Local Echo;	Prompt.	Advisory message.	---
<BK SP> Sends;	Prompt.	Advisory message.	---
New Line Mode;	Prompt.	Advisory message.	---
Insert Mode;	Prompt.	Advisory message.	---
Autowrap Mode;	Prompt.	Advisory message.	---
Cursor;	Prompt.	Advisory message.	---
EMULATION SETUP;	Prompt.	Advisory message.	---
Mobile Unit Type;	Prompt.	Advisory message.	---
Local Echo;	Prompt.	Advisory message.	---

Message	Reason	Solution	Reference Tech Note
Map Underline;	Prompt.	Advisory message.	---
Break Key;	Prompt.	Advisory message.	---
ANSI Setup;	Prompt.	Advisory message.	---
Control Codes;	Prompt.	Advisory message.	---
Backspace Key;	Prompt.	Advisory message.	---
MISCELLANEOUS SETUP;	Prompt.	Advisory message.	---
Test Options;	Prompt.	Advisory message.	---
Login Options;	Prompt.	Advisory message.	---
TEST OPTIONS;	Prompt.	Advisory message.	---
Printer Test;	Prompt.	Advisory message.	---

Message	Reason	Solution	Reference Tech Note
Scan Code Test;	Prompt.	Advisory message.	---
LOGIN OPTIONS;	Prompt.	Advisory message.	---
User Name;	Prompt.	Advisory message.	---
User Password;	Prompt.	Advisory message.	---
ON;	Prompt.	Advisory message.	---
OFF;	Prompt.	Advisory message.	---
Map;	Prompt.	Advisory message.	---
Don't Map;	Prompt.	Advisory message.	---
Enable Break;	Prompt.	Advisory message.	---
Disable Break;	Prompt.	Advisory message.	---

Message	Reason	Solution	Reference Tech Note
7 bit;	Prompt.	Advisory message.	---
8 bit;	Prompt.	Advisory message.	---
Send Delete;	Prompt.	Advisory message.	---
Send Backspace;	Prompt.	Advisory message.	---
Mobile Unit Setup;	Prompt.	Advisory message.	---
Scanner Options;	Prompt.	Advisory message.	---
Program Options;	Prompt.	Advisory message.	---
Special Options;	Prompt.	Advisory message.	---
Beeper Options;	Prompt.	Advisory message.	---
Exit to DOS;	Prompt.	Advisory message.	---

Message	Reason	Solution	Reference Tech Note
Backlight Time;	Prompt.	Advisory message.	---
Enter Key Action;	Prompt.	Advisory message.	---
Reset Options;	Prompt.	Advisory message.	---
Font Size;	Prompt.	Advisory message.	---
Portable Printer;	Prompt.	Advisory message.	---
Reprint Option;	Prompt.	Advisory message.	---
Data IDs;	Prompt.	Advisory message.	---
Internal/External;	Prompt.	Advisory message.	---
Modify Beeps;	Prompt.	Advisory message.	---
Message Beeps;	Prompt.	Advisory message.	---

Message	Reason	Solution	Reference Tech Note
Scan Identifier;	Prompt.	Advisory message.	---
AID Scan Setup;	Prompt.	Advisory message.	---
Long Scans;	Prompt.	Advisory message.	---
Scan Send;	Prompt.	Advisory message.	---
Yes;	Prompt.	Advisory message.	---
No;	Prompt.	Advisory message.	---
Normal;	Prompt.	Advisory message.	---
Double Wide;	Prompt.	Advisory message.	---
Double High;	Prompt.	Advisory message.	---
Double High and Wide;	Prompt.	Advisory message.	---

Message	Reason	Solution	Reference Tech Note
Errors Only;	Prompt.	Advisory message.	---
Automatic;	Prompt.	Advisory message.	---
All Messages;	Prompt.	Advisory message.	---
Reject;	Prompt.	Advisory message.	---
Truncate;	Prompt.	Advisory message.	---
Split;	Prompt.	Advisory message.	---
Do Not Send;	Prompt.	Advisory message.	---
Always Send;	Prompt.	Advisory message.	---
Last Field Only;	Prompt.	Advisory message.	---
Internal;	Prompt.	Advisory message.	---

Message	Reason	Solution	Reference Tech Note
External;	Prompt.	Advisory message.	---
none;	Prompt.	Advisory message.	---
monarch;	Prompt.	Advisory message.	---
pddumb;	Prompt.	Advisory message.	---
comtec;	Prompt.	Advisory message.	---
rascal;	Prompt.	Advisory message.	---
codewriter;	Prompt.	Advisory message.	---
comtec(S);	Prompt.	Advisory message.	---
User Name;	Prompt.	Advisory message.	---
Password;	Prompt.	Advisory message.	---

Message	Reason	Solution	Reference Tech Note
Frequency: Hz;	Prompt.	Advisory message.	---
Duration: ms;	Prompt.	Advisory message.	---
Delay: ms;	Prompt.	Advisory message.	---
Select Scanner;	Prompt.	Advisory message.	---
Setup Scanner;	Prompt.	Advisory message.	---
Scan Test;	Prompt.	Advisory message.	---
Scan Operation;	Prompt.	Advisory message.	---
Laser;	Prompt.	Advisory message.	---
Contact/Pulse;	Prompt.	Advisory message.	---
Contact/No Pulse;	Prompt.	Advisory message.	---

Message	Reason	Solution	Reference Tech Note
Auto/Pulse;	Prompt.	Advisory message.	---
Auto/No Pulse;	Prompt.	Advisory message.	---
Wand Simulation;	Prompt.	Advisory message.	---
VT100;	Prompt.	Advisory message.	---
VT220;	Prompt.	Advisory message.	---
SETUP;	Prompt.	Advisory message.	---
Mobile Unit IP/Radio;	Prompt.	Advisory message.	---
Host List;	Prompt.	Advisory message.	---
NULL;	Prompt.	Advisory message.	---